



UNITED COOLAIR

# MARVEL MINI HVAC MICROPROCESSOR CONTROLLER

## Installation, Operation and Maintenance Manual

Effective April 2022



\*\*\*Interactive PDF\*\*\*



we make life better™



## CONTENTS

<b>GENERAL PURPOSE</b> .....	<b>3</b>	SET POINTS .....	35
Marvel Mini™ - Controllable System Component Information .....	4	ALARM SET POINTS .....	39
AVAILABLE FUNCTIONS .....	5	Run Hours .....	40
<b>HARDWARE AND ARCHITECTURAL LAYOUT</b> .....	<b>6</b>	Clock Settings .....	40
MARVEL MAIN BOARD .....	7	Schedule .....	41
MARVEL TERMINAL (WALL CONTROL) .....	8	Set-Back .....	42
MARVEL WALL DISPLAY BUTTONS .....	9	CHANGE PASSWORD .....	44
PROGRAMMING AND OPERATING SCREENS ...	10	Technician Menu .....	44
DISPLAY DIMENSIONS .....	11	FAN DELAYS .....	46
CONNECTING CABLE .....	12	SYSTEM UNITS .....	47
SENSOR INSTALLATION AND ELECTRICAL TERMINATIONS .....	12	NETWORK .....	47
MARVEL MINI CONTROLLER – SEQUENCE OF OPERATION .....	19	SENSOR SETUP .....	48
STANDARD SYSTEM SAFETIES .....	24	MANUAL CONTROL .....	49
OPTIONAL SYSTEM SAFETIES .....	26	DIGITAL INPUTS .....	50
Marvel Terminal Keypad and Display Operation ...	27	ECONOMIZER .....	50
Controller Operation .....	27	CHANGE PASSWORDS .....	51
Changing Set Points, Parameters, And Values ...	28	SYSTEM INFORMATION .....	51
SYSTEM ENABLES .....	35	INPUT WIRING .....	51
		OPTIONAL BOARDS .....	53

## **GENERAL PURPOSE**

The Marvel Mini™ is a microprocessor based electronic programmable controller with a multi-tasking operating system used to control United CoolAir manufactured HVAC systems using a newly developed Multi-Application software package. With this new system all of the previous applications provided by United CoolAir are all now bundled into one software package. So this one Multi-Application software package can now handle standard heating, cooling, dehumidification, humidification, as well as the heat pump, Variable Air Volume, and Outdoor Air applications. The only difference will be the size of the hardware controller installed in each unit. Since this is a mini controller package, options are limited so please inquire with sales and marketing when there are questions. The basis of design for the Marvel Mini™ Controller is for a maximum of one compressor and/or one heater with two modulating analog outputs to regulate optional devices based on demand. All available device options are listed starting on page 4.

Each Marvel Mini™ controller comprises of two flash drives “volume 0”, having 32MB in which the main application program resides and cannot be accessed by the user and an additional drive “volume 1”, having 96MB of NAND flash memory available to the user and accessed through the USB port or FTP Protocol. Volume 1 is useful to the end user as there is free space to add unit-operating literature, web pages, and system logs. The microprocessor is based on 32 bit, 100 MHz so now variables can be communicated in 32bit data-type format.

Since the Marvel Mini™ controller has a multi-tasking operating system, it now supports networking of additional programmable controllers, remote user terminals, communicating devices as well as interfacing with Building Management Systems much easier than its predecessors that had BIOS firmware.

Figure 1 – System Layout is made up of the Marvel Mini™ main control board showing options for communicating devices, networking, building management and supervisory system setups. Customers have the option of either a built-in or wall mount display and keypad or even both of these if

desired. The Marvel Mini™ system also contains common required standard sensors as well as optional sensors that must be field installed and wired to the factory provided field interface terminal blocks in the air handlers electrical control box.

Each Marvel Mini™ has numerous standard setups built for interfacing with ECM Fans and VFDs for low ambient and/or Humidifier controllers through serial communication ports saving additional I/O for system sensors. The Universal Input channels have been developed so that a customer can replace or add a sensor in the field and set up the characteristics of the sensor under a sensor setup menu however, it is recommended to contact the local distributor or factory before doing so for detailed information.

The Marvel Mini™ is equipped with a set of plug in terminal block connectors used to connect the Main Board to the controlled devices (i.e. solenoid valves, compressor contactor(s), blower contactors, heater contactors, VFDs, etc.). The application program is stored in Flash Memory of the controller and the unit’s hardware setup and control set points and parameters are stored in permanent memory (even in case of power failure). The software program is designed for “smart control”, to automatically predict and project required changes based upon present readings over time intervals in efforts to proactively adjust to changing conditions. The Marvel Mini™ can be linked with Building Management Systems RS485 serial or Ethernet connections with customer provided communication protocol details.

As a standard unless otherwise specified, the Marvel Mini™ microprocessor-based Remote User Terminal unit comes complete with LCD Display and Keypad for viewing and setting of the control parameters (set points, proportional bands, dead bands, and alarm set points, system run hours, etc.). The Terminal also allows viewing of the operating parameters, staging of system components, and system demands. Connection between the Marvel Mini™ main board and remote user terminal is only required for viewing or changing of the operating conditions and set points.

## Marvel Mini™ - Controllable System Component Information

With this new format, one of the key benefits of the Marvel Mini™ application software is set up universally so that any of the following functions could literally be added to any of the corresponding channels. This means for example, any of the listed functions under Analog/Universal Inputs could be placed onto any of the Universal Channels U1 through U5 whereas in the past and with most control vendors, a software modification would be required. In addition now all of the Analog Inputs, Digital Inputs, Analog Outputs, and Digital Outputs are all selectable for any of their corresponding channels. So for instance the digital output for Compressor 1 could be configured on any of the Digital Outputs NO1 through NO6 (example of large controller maximum number of Digital Outputs). These Universal Functions for each of the four I/O Groups are:

### ANALOG/UNIVERSAL INPUTS

RETURN TEMPERATURE	COMPRESSOR LIQUID PRESSURE	
SPACE TEMPERATURE	SPACE HUMIDITY	
OUTDOOR AIR TEMPERATURE	WATER TEMPERATURE	OUTDOOR AIR HUMIDITY
SUPPLY AIR TEMPERATURE 1	RETURN HUMIDITY	

### ANALOG OUTPUTS

MODULATING HOT GAS BYPASS	MODULATING WATERSIDE ECONOMIZER	DISCHARGE PRESSURE VALVE 1
AIRSIDE ECONOMIZER	MODULATING REHEAT	
MODULATING HEATER	MODULATING HUMIDIFIER	

### DIGITAL INPUTS

COMPRESSOR 1 HIGH PRESSURE	REMOTE ON/OFF	HEATER HIGH LIMIT
COMPRESSOR 1 LOW PRESSURE	DIRTY FILTER	WATER FLOW
LOSS OF AIRFLOW	COMPRESSOR FREEZE STAT	SMOKE PURGE
DRAIN PAN OVERFLOW	FIRE/SMOKE ALARM	HEAT PUMP DEFROST SWITCH

### DIGITAL OUTPUTS

SUPPLY BLOWER	HEATER	GLOBAL ALARM OUTPUT
OUTDOOR/FRESH AIR DAMPER	REVERSING VALVE	
COMPRESSOR	REHEAT	

## AVAILABLE FUNCTIONS

The following is a listing of available functions please inquire with the local United CoolAir Distribution for unit design configurations with these functions:

- One Compressor Staged ON/OFF.
- One Heater Staged ON/OFF or Modulating or Hot Water Coil or Steam Coil for modulating control valves at 0-10vdc output.
- Modulating Humidifier controlled via Modbus Communications.
- Modulating Hot Gas Bypass for system capacity control.
- Hot Gas Reheat either by Stage or Modulating.
- Compressor safeties for high and low pressure are wired independently for true notification of which failure High or Low Pressure.
- An Air Switch has been incorporated to turn off cooling, heating, dehumidification, and humidification in the event of a loss of air flow due to a broken v-belt or other means.
- On a heater high limit failure the heaters are locked out, but automatically reset when the safety resets. The display and alarm button will indicate an alarm occurred with the heating function.
- Airside or Waterside Economizer.
- Integrated Economizer function that allows Mechanical Cooling Compressors to assist is also available.
- Networking of multiple units with Unit Lead Lag and Backup unit assist is built into the main software platform so if multiple units are shipped to the field and the customer decides to network the units together at a later date the software is already capable of networking up to 16 total units.
- Building Management Systems via the following BMS Protocols is available: BACnet™ Modbus®, HTML Web Pages

## HARDWARE AND ARCHITECTURAL LAYOUT

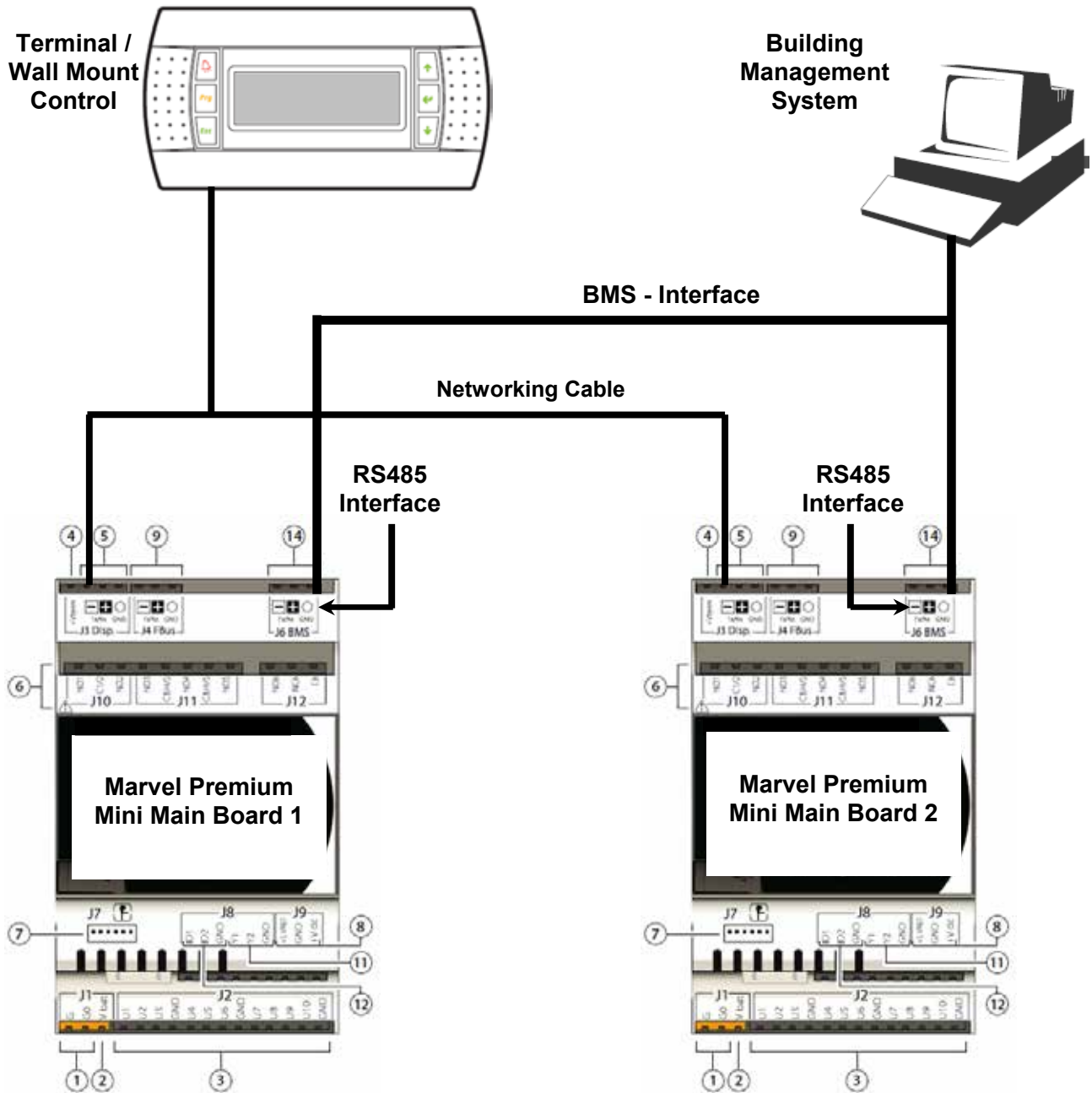






FIGURE 1 – HARDWARE / ARCHITECTURE LAYOUT



## MARVEL TERMINAL (WALL CONTROL)

The Marvel Terminal is complete with LCD Display and Keypad. The Terminal has LED indicators integral to the buttons. A description of each indicator light is discussed with the function of the each button starting on page 11.

The Marvel Terminal contains no sensors and does not need to be located in the building's space that is being conditioned. The Terminal can be mounted up to 1000 feet from the equipment. See Figure 3 – Terminal below for reference. The Terminal is made up of the following components:

- A. External buttons Prg, Esc, , , and  or  (adjustment buttons) with integral LED indicators.
- B. Submenus include System ON/OFF, System Status, System Enables, Set Points, Alarm Set Points, Run Hours, Day Min/Max, Clock Settings, Schedule, Setback, Unocc Control, Change Passwords, Technician Menu, Factory Menu
- C. A 22 character by 8 row LCD Display with English text for ease of understandability for adjustment.

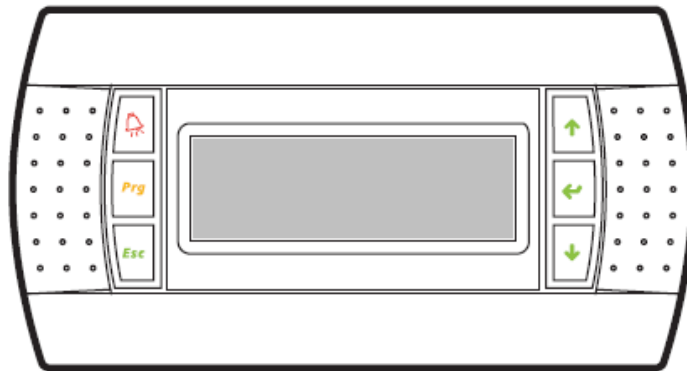








FIGURE – 3 TERMINAL (WALL MOUNT) CONTROL








## MARVEL WALL DISPLAY BUTTONS

See Figure 4 – Control Buttons for reference.


 ALARM BUTTON	 UP BUTTON
 PROGRAM BUTTON	 ENTER BUTTON
 ESCAPE BUTTON	 DOWN BUTTON

**FIGURE 4 – CONTROL BUTTONS**


### **ALARM BUTTON**

The  button is used for viewing the present alarms with the system. During an alarm condition, the  button is illuminated a continuous Red. Depending on the type of alarm, the system may shut down or continue to operate. Some types of alarms are just simple faults known as indicators which are not harmful to the operation of the unit but may require attention in the near future. Pressing the  button will reveal what alarm caused the system to shut down. To reset an alarm, press the  button until the screen displays “NO MORE ALARMS; To reset the alarm, simply press the  button again to reset the alarm.

### **PROGRAM BUTTON**

The **Prg** button is used to enter into menus and sub menus. On controllers with built in displays, the  is the program button.

### **ESCAPE BUTTON**

The **Esc** button is used to return to the main system status from a menu or sub-menu or escape to the previous menu from a sub-menu. On controllers with built in displays, the  is the escape button.

### **UP BUTTON**

The up button is used to scroll upward through status screens, menus, sub-menus and change the value of parameters or settings.

### **ENTER BUTTON**

Upon application of power to the system, the splash screens appear then the main status home screen will appear. Use the enter button to move the cursor to the next field (set points or parameters) where the change is desired. Also use the Enter button to initialize/save changed parameters and set points into memory.

### **DOWN BUTTON**

The down button is used to scroll downward through status screens, menus, sub-menus and change the value of parameters or settings.

## PROGRAMMING AND OPERATING SCREENS

As shown in Figure 4 previous, each of the buttons are used to access specific locations to Read or Change (such as set point) values. Below is a list of the menus that are accessible from the wall mount controller. By pressing the **Prg** button multiple times, the following menu will appear:

4. **SET POINTS menu** – Used for changing temperature and humidity settings. It is also used to set temperature high and low alarm set points as well as humidity high and low alarm set points. If customers have the pressure control option, settings will also appear to adjust duct or room pressure.
5. **TIME CLOCK SETTINGS menu** – Used for changing the Time Clock Readings to the current Time and Date. This menu is also used for setup of Daylight Savings Time based on region and enabling of the Night Set Back Function. Once the Night Set Back Function is enabled, the type of control (Temp/Humidity Setback) is enabled and Set Points for Temperature and Humidity Setback Control shall appear as well as the day of the week to enable Night Set Back and time of day for occupied and unoccupied period.
6. **SYSTEM ENABLES menu** – This sub-menu allows for re-enabling of system functions (System ON/OFF, Humidification/Dehumidification, Compressors, Heaters, ON/OFF and Modulating Reheat, etc.) after an alarm condition has occurred.
7. **EQUIPMENT RUN HOURS menu** – Displays the operational run hours of system components such as Fan, Humidifier, Compressors, Heaters, etc.).
8. **ANALOG/DIGITAL INPUTS/OUTPUTS menu** – This sub-menu is used to calibrate sensors and alarm input setup settings.
9. **PRG & ESC (Factory Setup menu)** – Used for changing the Factory Default System settings. It is used to change control functions with their equipment.

### LCD Display

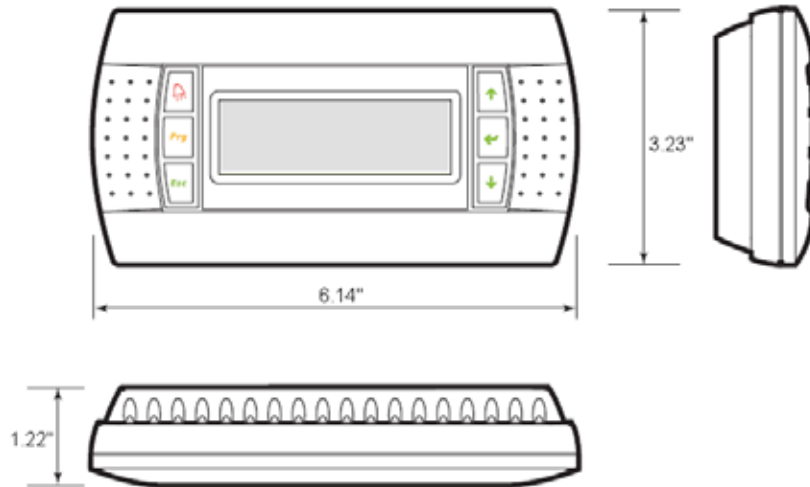
The Terminal provides eight lines of twenty-two characters per line LCD Display. The character is 5 mm in height. See Figure 5 – LCD Display.

U01 Mon 07:21 03/19/17	
Return Hum >	55.0%
Return Temp>	74.7 °F
Supply Temp>	57.2 °F
One Compressor ON	

FIGURE 5 – LCD DISPLAY

## DISPLAY DIMENSIONS

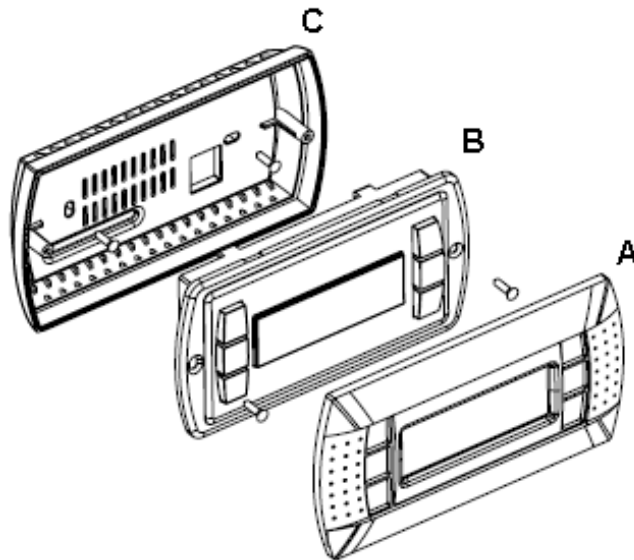
Refer to Figure 6 – Terminal Dimensions for dimensional data. Dimensions shown are in inches.



**FIGURE 6 – TERMINAL DIMENSIONS**

## Marvel Display (Terminal) – Wall Mounting

Refer to Figure 7 – Wall Mounting for instructions to mount the Terminal to a wall.



**FIGURE 7 – WALL MOUNTING**

Components of the Wall Controller:

- A. Faceplate
- B. Wall Controller
- C. Mounting Plate

For best results in mounting of the wall controller, obtain an single position Receptacle/Switch Electrical Box which typically measures approximately 3.75" high x 2.25" wide x 2.83" deep. Install the box sideways (90 degrees) internal to the wall from the original upright position. The box may be installed on metal or wood studded framing. Route the field provided connecting cable to the box.

1. Remove the Faceplate "A" from the Wall Controller.
2. Using a small straight screw driver, remove the two screws which secure the Wall Controller "B" to the Mounting Plate "C".
3. Route the Connecting Cable through the back of the Mounting Plate "C" then screw the mounting plate to the electrical box.
4. Plug the field provided Connecting Cable to the Wall Controller "B" then reinstall the Wall Controller "B" back onto the Mounting Plate "C".
5. Connect the field supplied standard phone cable into the coupler at the Main Board end.

## CONNECTING CABLE

The Marvel Terminal (Wall Control) connects to the Marvel Main Board using a factory provided 100-foot phone cable. Install the factory supplied 6-conductor cable from the Marvel Main Board located inside the control box to the location the Marvel Terminal shall be installed.

**CAUTION:** The factory provided is a special cable. If longer or shorter cable is desired, please contact the local Distributor for a longer/shorter length making sure to provide the desired length. NEVER ATTEMPT TO LENGTHEN THE FACTORY SUPPLIED CABLE as this cable specific pin connections. The Marvel Terminal will not work if the pin terminations are not correct and may damage the Marvel Main Board or blow the fuse due to improper connections.

## SENSOR INSTALLATION AND ELECTRICAL TERMINATIONS

### ELECTRICAL CONNECTIONS

All electrical wiring must be in accordance with NEC (National Electrical Code)/NFPA (National Fire Protection Agency), as well as state and, local building codes. Refer to the specifications section or the unit's data tag for the unit's power requirements.

## SERVICE DISCONNECT

A field installed fused single point power service disconnect is required. Install the service disconnect in accordance with NEC, State, and Local building codes. NEC guidelines require the unit's disconnect be installed within sight of the unit.

A factory provided power block is installed internal to the unit's electrical control panel. Route the main power wires in accordance with electrical codes to the field provided unit service disconnect and terminate them on the line side of the disconnect. Route the power wires from the Load side of the field provided service disconnect to unit power block inside the electrical control panel.

A ground termination point is located within the unit's electrical control panel. All units must have a hard wired ground from a source Earth Ground.

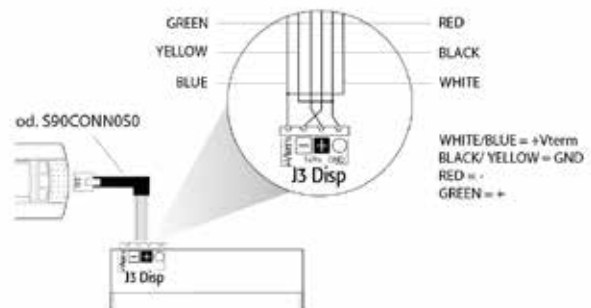
**IMPORTANT: Metal Conduit is not an acceptable source of ground as there may be air gaps between connection points.**

## SENSOR FIELD MOUNTING & WIRING

All sensors and optional components that must be field installed and wired to the electrical control panel must be wired as shown on the electrical diagram provided with the unit. The installation instructions correspond with the electrical diagram for the field installable components. For special order options which are not listed within these sensor installation instructions, please refer to unit's factory provided electrical diagram and the installation instructions provided with each component for proper installation requirements.

### c.pCOmini

Use the accessory cable P/N S90CONN0S0, connected as shown in the figure. The maximum distance allowed between controller and terminal is 100 Feet.



**FIGURE 8 – CONNECTING THE TERMINAL**

## Duct Mount Supply Air Temperature Sensor

The duct mount supply air temperature sensor(s) shown in Figure 9 – Supply Air Sensor must be field installed in the supply air ducting. It is recommended to install the supply temperature sensor 1/2 to 2/3 of the distance down the straightest length of ducting.

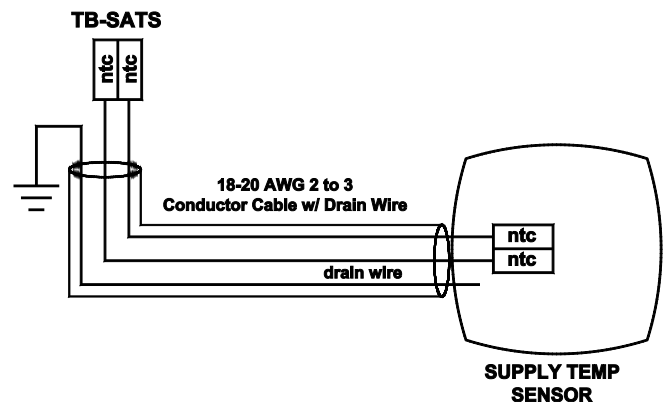
### Mounting

1. Cut out the mounting template provided with the sensor.
2. Select the location to mount the sensor and drill a hole through the supply air duct at least  $\frac{3}{4}$ " in diameter.
3. Using a  $\frac{7}{64}$ " drill-bit, drill the three fastening screw holes located on the template for the fastening ring.
4. Remove the duct sensor's mounting ring from the duct probe being careful not to lose the sealing gasket.
5. Position the mounting ring over the  $\frac{3}{4}$ " hole drilled in step 2.
6. Use three (3) field provided #6 x  $\frac{3}{4}$ " Pan Head sheet metal screws and fasten bracket to the duct.
7. Place the probe through the mounting bracket and into the supply air duct.
8. Using the screw provided with the sensor installation kit, place the screw into the clamping ring and tighten the ring to secure the sensor to the clamping ring.

### Wiring

Figure 10 – Supply Air Sensor Wiring shows how the sensor is wired. Using a minimum 18-20 AWG 300 volt rated two conductor shielded cable with drain wire make the following electrical connections. The supply air temperature sensor is non-polarity observant.

1. Connect from one NTC terminal inside the supply air temperature sensor to terminal block TB-SATS – NTC inside the unit's electrical control box.
2. Connect the other NTC terminal inside the supply air temperature sensor to terminal block TB-SATS – NTC inside the unit's electrical control box.
3. Connect the drain wire to ground inside the unit's electrical control box.



**FIGURE 10 – SUPPLY AIR SENSOR WIRING**

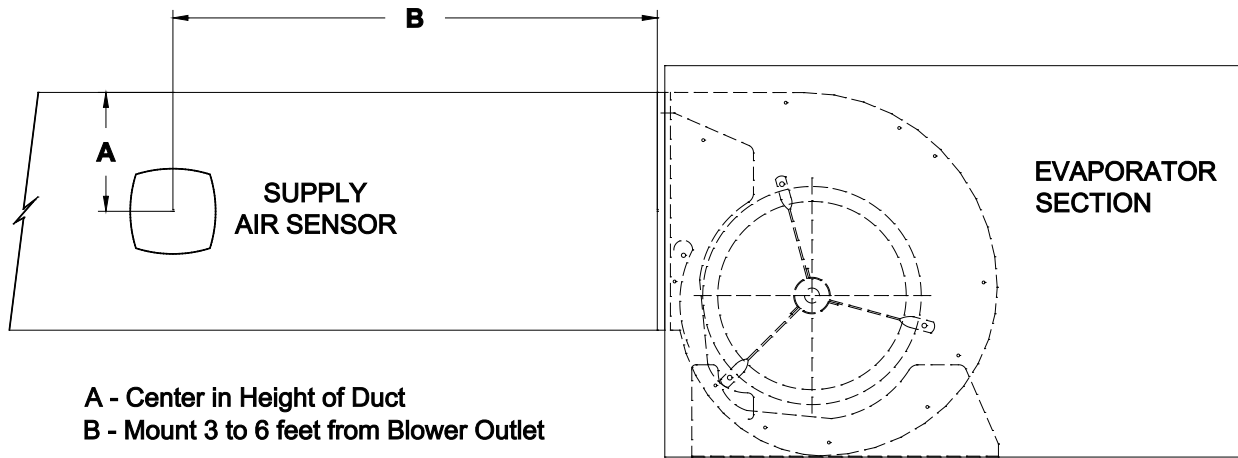
## Duct Mount Return Air Temperature Sensor (Optional Humidity)

The return air temperature sensor shown in Figure 11 – Return Air Sensor must be field installed in the return air ducting close to the unit. The return air sensor must be located relatively close to the Filter Rack of the unit.

**IMPORTANT:** If the unit has optional humidity control, please observe when making electrical connections.

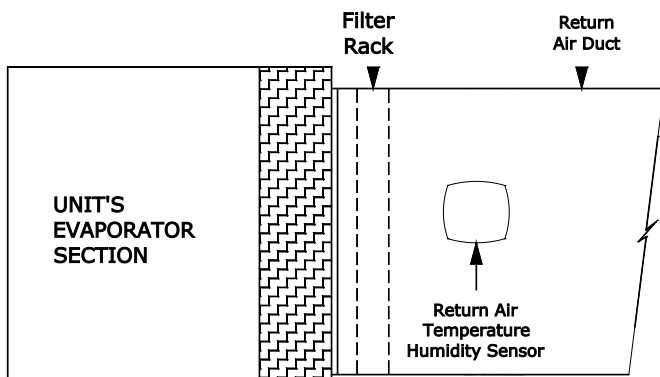
### Mounting

1. Cut out the mounting template provided with the sensor.
2. Select the location to mount the sensor and drill a hole through the supply air duct at least  $\frac{3}{4}$ " in diameter.
3. Using a  $\frac{7}{64}$ " drill bit; drill the three fastening screw holes located on the template for the fastening ring.
4. Remove the duct sensor's mounting ring from the duct probe being careful not to lose the sealing gasket.
5. Position the mounting ring over the  $\frac{3}{4}$ " hole drilled in step 2.
6. Use three (3) field provided #6 x  $\frac{3}{4}$ " Pan Head sheet metal screws and fasten bracket to the duct.
7. Place the probe through the mounting bracket and into the supply air duct.
8. Using the screw provided with the sensor installation kit, tighten the clamping ring.



A - Center in Height of Duct  
B - Mount 3 to 6 feet from Blower Outlet

**FIGURE 9 – SUPPLY AIR SENSOR**



**NOTES:** 1. Return Temp & RH Sensor is Factory Provided & Field Installed.

**FIGURE 11 – RETURN AIR SENSOR**

## Wiring

Figure 12 – Return Air Temperature/Humidity Sensor Wiring shows how the sensor is wired. Using a minimum 18-20 AWG 300 volt rated two conductor shielded cable with drain wire make the following electrical connections. The max wire length should not exceed 100ft with 20AWG wire or 150ft with 18AWG wire.

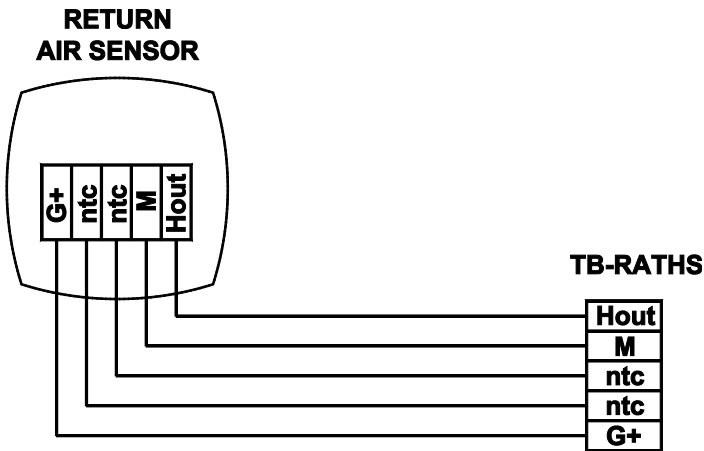
**NOTE:** Use a minimum two conductor cable for temperature only. Use a minimum five conductor for temperature and humidity control.

1. The return air temperature sensor is non-polarity observant.
2. Connect from one NTC terminal inside the return air temperature sensor to TB – RATS - NTC.
3. Connect the other NTC terminal inside the temperature sensor to TB – RATS - NTC.
4. Connect the drain wire to ground at the unit's electrical control panel end only.

## Optional Humidity Control

If the sensor for Return Air has the optional humidity sensor, continue with steps 7, 8, and 9.

7. Connect from the terminal marked G+ inside the sensor to terminal TB-RATHS – G+ inside the unit's electrical box.
8. Connect from the terminal marked M inside the sensor to terminal TB-RATHS – M inside the unit's electrical control box.
9. Connect from the terminal marked Hout inside the sensor to terminal TB-RATHS – Hout inside the unit's electrical control box.



**FIGURE 12 – RETURN AIR TEMPERATURE/HUMIDITY SENSOR WIRING**

(Example shown with TB-RATHS humidity connections option)

### Room/Space Wall Mount Temperature and Optional Humidity Sensor

The room temperature with humidity sensor option must be field installed in the room being conditioned. Never install the sensor at a location that can be influenced by solar gain such as sunlight or by drafts such as doors opening/closing or direct movement of conditioned air such as from supply air outlet grills. The location of this sensor should be reading mixed air, which means the best location should be close to a return air grille. The installation height should be between 40" to 60" above the room's floor.

**BE AWARE:** If the unit has optional humidity control, polarity must be observed when making electrical connections.

**NOTE:** Use a minimum two-conductor cable for temperature only. Use a minimum five conductor for temperature and humidity control. It may be required to preinstall this wire (addition of drywall, paneling, ceilings, etc.) if the interior room shall be completed before this sensor will be installed. If the interior is complete, install the cable as required being careful not to damage the cable during installation.

### Mounting

1. Cut out the mounting template provided with the sensor.

2. Select the location to mount the sensor and drill the appropriate size holes (for the factory supplied wall anchors) into the surface the sensor is being installed on.
3. Install the wall anchors as required for installation of the sensor.
4. Drill a through hole approximately 3/8" to 1/2" in diameter for the cable as required.
5. Place the cable through the back of the sensor.
6. Using the screws provided, screw the sensor to the wall.

### Wiring

Figure 13 – Room Temperature Humidity Sensor Wiring shows the electrical connections for the sensor. Using a minimum 18-20 AWG 300 volt rated two conductor shielded cable with drain wire make, the following electrical connections.

**NOTE:** Use a minimum two-conductor cable for temperature only. Use a minimum five conductor for temperature and humidity control.

1. The room air temperature sensor is non-polarity observant.

### Room/Space Wall Mount Temperature Sensor Only

2. Connect from one NTC terminal inside the room air temperature sensor to TB-RTS – NTC (room temperature only)
3. Connect the other NTC terminal inside the room air temperature sensor to TB-RTS – NTC (room temperature only).

Or

### Room/Space Wall Mount Temperature / Humidity Sensor

4. Connect from one NTC terminal inside the room temperature/humidity sensor to TB-RTHS – NTC (room temperature and humidity sensor)
5. Connect the other NTC terminal inside the room temperature/humidity sensor to TB-RTHS – NTC (room temperature and humidity sensor).
6. Connect the drain wire to ground at the unit's electrical control panel end only.

### Optional Humidity Control

If the Room Temperature and Humidity Sensor for Room Air has the optional humidity sensor, continue with steps 7, 8, and 9.

7. Connect from the terminal marked G+ inside the sensor to terminal TB-RTHS – G+ inside the unit's electrical box.
8. Connect from the terminal marked M inside the sensor to terminal TB-RTHS – M inside the unit's electrical control box.
9. Connect from the terminal marked Hout inside the sensor to terminal TB-RTHS – Hout inside the unit's electrical control box.

(Example shown with TB-RTHS humidity connections option)

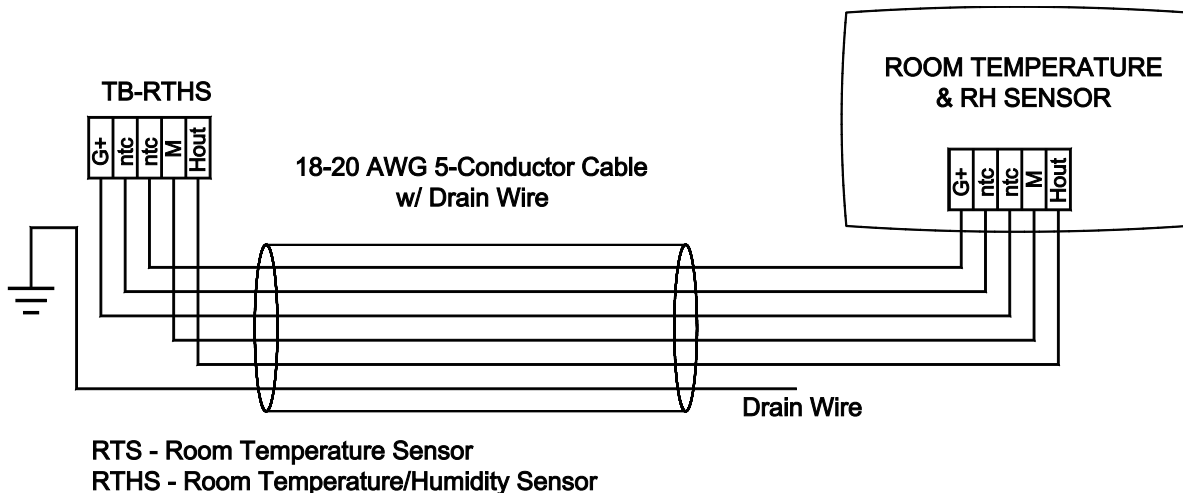
### Duct Mount Outdoor Air Temperature Sensor

The duct mount outdoor air temperature sensor shown in Figure 14 – Outdoor Air Temperature / Humidity Sensor must be field installed in the outdoor air ducting close to an outdoor air louver but back inside of the ducting far enough that it does not rain onto the sensor. It should also be located before the outdoor air inlet damper in order to always

monitor the outdoor air temperature and humidity correctly unless the unit will always be providing a minimal amount of outdoor air when occupied (in this case the sensor could be located between the outdoor air louver and the unit).

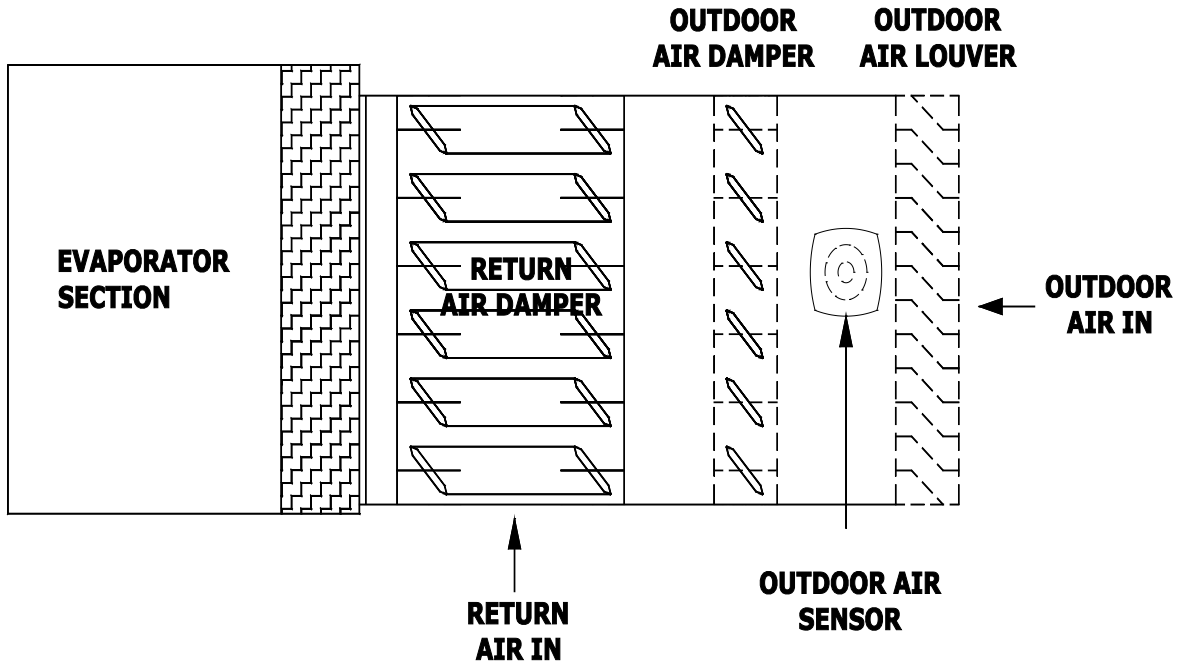
**IMPORTANT:** If the unit has humidity control for airside economizer, polarity must be observed when making electrical connections.

1. Cut out the mounting template provided with the sensor.
2. Select the location to mount the sensor and drill a hole through the supply air duct at least 3/4" in diameter.
3. Using a 7/64" drill bit; drill the three fastening screw holes located on the template for the fastening ring.
4. Remove the duct sensor's mounting ring from the duct probe being careful not to lose the sealing gasket.
5. Position the mounting ring over the 3/4" hole drilled in step 2.
6. Use three #6 x 3/4" Pan Head sheet metal screws and fasten bracket to the duct.
7. Place the probe through the mounting bracket and into the supply air duct.
8. Using the screw provided with the sensor installation kit, tighten the clamping ring.



**FIGURE 13 – ROOM TEMPERATURE HUMIDITY SENSOR WIRING**





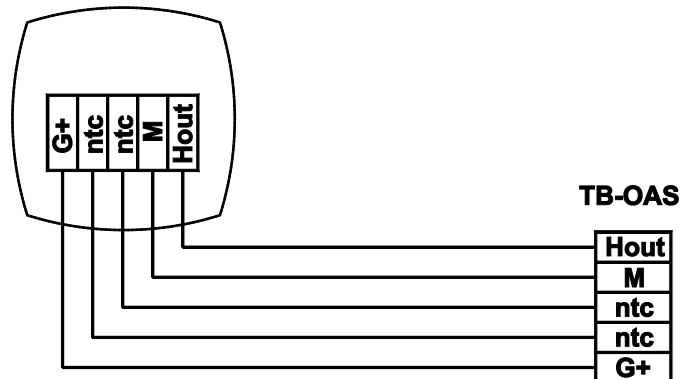
**FIGURE 14 – OUTDOOR AIR TEMPERATURE / HUMIDITY SENSOR**

**Wiring**

Using a minimum 18-20 AWG 300 volt rated two conductor shielded cable with drain wire make the following electrical connections. Use a minimum five conductor for temperature and humidity control. Refer to Figure 15 – Outdoor Temperature/Humidity Sensor Wiring.

1. The return air temperature sensor is non-polarity observant.
2. Connect from one NTC terminal inside the outdoor temperature/humidity sensor to TB-OTHS – NTC.
3. Connect the other NTC terminal inside the outdoor temperature/humidity sensor to TB-OTHS – NTC.
4. Connect the drain wire to ground at the unit's electrical control panel end only.
5. Connect from the terminal marked G+ inside the outdoor temperature/humidity sensor to terminal TB-OTHS – G+ inside the unit's electrical box.
6. Connect from the terminal marked M inside the outdoor temperature/humidity sensor to terminal TB-OTHS – M inside the unit's electrical control box.
7. Connect from the terminal marked Hout inside the outdoor temperature/humidity sensor to terminal TB-OTHS – Hout inside the unit's electrical control box.

**OUTDOOR AIR SENSOR**



**FIGURE 15 – OUTDOOR TEMPERATURE/HUMIDITY SENSOR WIRING**

## Remote Alarm Output Option

On systems without BMS Communications, an option can be provided for Remote/Global Alarm Output, which closes a set of voltage free dry contacts on global alarm to terminals TB-RA – 1 and TB-RA – 2. With this option, look for terminal block TB-RA. The device must not exceed 10 amps at 240 VAC or 10 Amps at 24 VDC. Install two conductors 14 – 18 AWG 600 volt rated from the Remote Alarm device to the unit's terminal blocks TB-RA. Whether connecting a buzzer or an indicator light, the device must have a separate power source. Determine which side of the device to disconnect (hot or common/neutral) through the factory provided dry contact terminal blocks and wire as follows:

### Wiring the Remote/Global Alarm Output

1. Remove one wire from the Coil of the Alarm Device and wire nut or splice cap this wire with one of the two wires going to the Remote Alarm interlock wiring.
2. Connect the other wire of the Remote Alarm interlock wiring to the location of the wire removed from Remote Alarm device.
3. At the unit, connect one wire to terminal TB-RA – 1.
4. Connect the other wire to TB-RA – 2.

## Remote Water Pump ON/OFF Option

If the customer's system has an ON/OFF Water Pump that must be commanded on when there is a call for cooling, and the unit has the optional Remote Water Pump ON/OFF terminal blocks, the terminal blocks for interlocking this function are TB-RWP – 1 and TB-RWP – 2. Determine whether the Hot or Common/Neutral shall be wire through the contacts for Remote Water Pump interlock. Next, install two conductors 14 – 18 AWG 600 volt rated from the Remote Water Pump's Contactor/Starter location to the unit's terminal blocks TB-RWP. Connect the wires as follows:

### Wiring at the Pumps Contactor/Starter

1. Remove one wire from the Coil of the Water Pump's Contactor/Starter and wire nut or splice cap this wire with one of the two wires going to the Remote Water Pump interlock wiring.
2. Connect the other wire of the Remote Water Pump interlock wiring to the location of the wire removed from the Contactor/Starter Coil.
3. At the unit, connect one of the wires to TB-WP – 1.
4. Connect the other wire to TB-WP – 2.

## Optional Airside Economizer Damper Control

If the customer's system has optional Airside Economizer Dampers that must be modulated for free cooling, the terminal blocks for interlocking this function are TB-ASE – 1, TB-ASE – 2, and TB-ASE – 3. Install three conductors 16 – 18 AWG minimum 300 volt rated from the Airside Economizer Damper Actuators' location to the unit's terminal blocks TB-OAD.

Connect the wires as follows:

### Wiring of the Airside Economizer Damper Actuators

1. Connect the Common wire at the Damper Actuator to terminal TB-ASE – 1 inside the unit's electrical box.
2. Connect the 24 vac wire at the Damper Actuator to terminal TB-ASE – 2 inside the unit's electrical box.
3. Connect the 0-10 vdc wire at the Damper Actuator to terminal TB-ASE – 3 inside the unit's electrical box.

## Optional Outdoor Air Damper Control

If the customer's system has an Outdoor/Fresh Air Damper that must be opened or closed by the unit during system start and occupancy schedule, the terminal blocks for interlocking this function are TB-OAD – 1 and TB-OAD – 2. Determine whether the Hot or Common/Neutral shall be wired through the contacts for Outdoor Air Damper interlock. Next, install two conductors 16 – 18 AWG minimum 300 volt rated from the Outdoor Air Damper Actuator's location to the unit's terminal blocks TB-OAD. Connect the wires as follows:

### Wiring at the Outdoor Air Damper

1. Connect the Common wire at the Damper Actuator to terminal TB-OAD – 1 inside the unit's electrical box.
2. Connect the 24 vac wire at the Damper Actuator to terminal TB-OAD – 2 inside the unit's electrical box.

## Optional Smoke Detector

If the factory ordered smoke detector option is provided, four terminations shall be required. Follow the installation/mounting instructions provided with the device. Install a four conductor cable minimum 18 AWG 300 volt rated from the smoke detector to the terminal blocks labeled TB-SD provided inside the unit.

## Wiring

1. Terminate from the device terminal number 9 to the factory provided terminal TB-SD – 9.
2. Terminate from the device terminal number 10 to the factory provided terminal TB-SD – 10.
3. Terminate from the device terminal number 6 to the factory provided terminal TB-SD – 6.
4. Terminate from the device terminal number 16 to the factory provided terminal TB-SD – 16.

On units with both a supply and return smoke detectors, these terminals shall have terminal designations of TB-SSD for Supply Smoke Detector and TB-RSD for Return Smoke Detector instead of TB-SD. The terminal number pattern is the same. Terminal 9 inside the Smoke Detectors terminate to terminal 9, 10 inside the smoke detector terminates to 10 inside the unit and so on. The only difference is the location of the smoke detectors (supply or return air streams). Please remember to account for this during installation.

## Optional Fire Stat Terminations

For a Field Supplied Fire Stat, two terminations shall be required. Follow the installation/mounting instructions provided with the device. Install a two-conductor cable minimum 18 AWG 300 volt rated from the smoke detector/fire stat to the terminal blocks provided inside the unit.

## Wiring

1. Locate the Normally Closed dry contact terminations, which open on alarm, inside of the Firestat.
2. Terminate from one of the terminals inside of the Fire Stat to the factory provided terminal TB-FS – 1.
3. Terminate from the other terminal inside of the Fire Stat to the factory provided terminal TB-FS – 2.

## Optional Remote On/Off Control

With the optional Remote On/Off Control, the unit will start when a voltage free dry contact closure is provided to Terminals TB-RMTO – 1 and TB-RMTO – 2. This closure should be provided by a dry contact closure switch installed at a remote location. Install two conductors minimum 18 AWG 300 volt rated from the Remote ON/OFF Switch location to the unit's terminal blocks TB-RMTO. Connect the wires as follows:

## Wiring

1. Connect one wire at the Remote ON/OFF switch to one termination pole of the switch.
2. Connect the other wire of the Remote ON/OFF switch to the other termination pole of the switch.
3. At the unit, connect one of the wires to TB-RMTO – 1.
4. Connect the other wire to TB-RMTO – 2.

## MARVEL MINI CONTROLLER – SEQUENCE OF OPERATION

### Outdoor Air Damper (option)

On units without the Airside Economizer option, the system has an option for a Fresh Air Damper Output. If the Fresh Air Damper Output is enabled and the system is in the Occupied Mode, the output will open the outdoor air damper once the System ON/OFF is set to the ON position. After the initial startup delay of 5 seconds (default and field adjustable), the output for the fresh air damper will supply a dry contact closure to start the Fresh Air Damper. This option allows the damper to drive open based on two methods.

1. Outdoor Air Damper Time Delay – Allows the Outdoor Air Damper to drive open for the adjustable damper time delay before starting the Supply Air Blower.
2. Outdoor Air Damper End Switch – Allows the Outdoor Air Damper to drive open but will not start the unit's Supply Air Blower(s) until the Outdoor Air Damper End Switch provides contact closure back to the Marvel Multi-Application controller verifying that the Outdoor Damper is open.

### Outdoor Air Damper End Switch (option)

On units with the optional Outdoor Air Damper End Switch enabled, the Marvel Mini Controller will not start the Supply Air Blower until there is contact closure on the Outdoor Air Damper End Switch proving that the Outdoor Air Damper is open. If the controller does not receive proof that the outdoor air damper is open within the specified adjustable time delay, the Marvel Multi-Application controller will provide and Alarm to alert personnel that the Outdoor Air Damper failed to open.

## **Supply Air Blower**

Once the Outdoor Air Damper is open either by time delay timeout or by proof of the damper end switch contact closure, the controllers blower output for the Supply Air Blower energize the blower contactor for the Supply Air Blower Motor. During the Occupied Mode, the blower will operate continuously unless the system is set to operate based on system demands (Cooling, Heating, Dehumidification, or Humidification). The unit controller has a selection to set the blower(s) to operate solely based on System Demands (Cooling, Heating, Dehumidification, or Humidification) only on units with Constant Air Volume and non-Outdoor Air systems.

## **Airside Economizer Mode (option)**

Airside Economizer is an optional feature for free cooling that requires a factory-provided duct mount type, field-installed, Outdoor Air Temperature and Humidity sensor, a factory provided wall or duct mountable Return Air Temperature and Humidity sensor, and a factory supplied duct mount Supply Air or Mixed Air Temperature sensor. With the Airside Economizer Option, there is a minimum damper position set point to maintain a minimum amount of fresh outdoor air based on regional code requirements. Also with the Airside Economizer Option, there is a maximum damper position set point to maintain a maximum amount of outdoor air based on maximum outdoor air and airflow limits required. The minimum and maximum outdoor air damper set points are field adjustable under the Technician Menu - Economizer Setup.

If the Cooling Demand rises above minimum damper position set point, and the Outdoor Air Enthalpy is less than the Return Air Enthalpy, and the Outdoor Air Temperature is below the Outdoor Air Temperature Set Point minus the Outdoor Air Temperature Band Set Point, the unit will perform Airside Economizer mode of operation. The amount of demand for Airside Economizer can be viewed by looking at the System Demands screen for Air Side Economizer x%. When operating in airside economizer mode, the outdoor air dampers are modulated to the position that the Economizer demand is calling for. If the outdoor air temperature is less than the Mixed/Supply Air Temperature Set point, the system will regulate the Outdoor and Return Air Dampers to maintain the Mixed Air/Supply Air Temperature Set point.

## **Waterside Economizer Mode (option)**

Waterside Economizer Mode is an option available for a more energy efficient method of cooling when customers have cooling towers available that can periodically supply water at a temperature of 55.0°F or lower. The Waterside Economizer option requires a factory-provided, factory-installed, water temperature sensor to monitor the inlet water temperature to the unit. If the entering water temperature is below the Water Temperature Set Point minus the Water Temperature Band Set Point, the controller regulates the water valve position in an effort to maintain the cooling set point.

Waterside Economizer Mode will stop when the Cooling Demand is 0% or the entering water temperature rises above the Water Temperature Set Point plus the Water Temperature Band Set Point. When the Water Temperature rises above the Water Temperature Set Point plus the Water Temperature Band Set Point and there is still a demand for cooling, the unit will revert back to mechanical cooling with compressors to provide the required cooling to meet the cooling demand.

## **Waterside Economizer plus Mechanical Cooling Assist (option)**

The Mechanical Cooling plus Waterside Economizer Assist option follows the same sequence of operation as the Waterside Economizer option. If the customer selects the Waterside Economizer plus Mechanical Cooling Assist Option, the water piping shall be piped internally so that mechanical cooling will be able to assist the waterside economizer operation. The controller shall be enabled for the mechanical cooling assist option. The Compressors will be staged when the Waterside Economizer Demand is equal to 100% for greater than the Economizer Assist (field adjustable) time delay. The amount of compressors shall be limited based on the water temperature.

## **Chilled Water Mode (option)**

Should the system have the Chilled Water Mode option, the control valve for chilled water mode could be either ON/OFF or Modulating depending on customer preference at the time of order. If the Chilled Water Valve is ON/OFF (open/close) type, the valve will energize/de-energize based on

start and hysteresis points much like a compressor (refer to the next paragraph of Cooling Mode for example of “start and hysteresis points”). If the Cooling Demand is greater than the Chilled Water Valve Start Set Point plus the Chilled Water Valve Hysteresis Set Point, the valve will open completely. Should the Cooling Demand be less than the Chilled Water Start Set Point minus the Chilled Water Hysteresis Set Point, the valve will be closed. Should the Chilled Water Valve type be modulating, the valve is modulated open or closed based on the percentage of Cooling Demand so if the Cooling Demand is 60% of the 0 to 100% cooling demand cooling range, then the chilled water valve will be 60% open.

### Cooling Mode by Return Air Temperature

Cooling by Return Air Temperature is based on the Cooling Demand. This Cooling Demand is calculated by the Return Air Temperature, Return Air Temperature Set point, and Return Air Temperature Band Set Point. If the Return Air Temperature is greater than or equal to the Return Air Temperature Set Point plus  $\frac{1}{2}$  of the Return Air Temperature Band Set Point, the Cooling Demand shall be 100%.

Compressors are then staged based on Compressor Start and End points. Each compressor starts when the Cooling Demand rises above its Start point. Each compressor stops when the Cooling Demand falls below the previous compressors start point. The Compressor Start and End points are based on the maximum number of compressors enabled.

**Example:** In a two-stage compressor system, the Start point for Compressor 1 is 33.3% and the End point is 0.0%. Compressor 1 energizes when the Cooling Demand rises above the Start point of 33.0% and stops at 0.0%. These Start and End points are determined by the program and are not field adjustable.

**Important:** Cooling Start and End points also allow for a buffer around the Temperature Set Point to help prevent overshoot.

### Heating Mode by Return Air Temperature

Heating by Return Air Temperature is based on the Heating Demand. This Heating Demand is calculated by the Return Air Temperature; Return Air Temperature Set point and Return Air Temperature Band Set point. If the Return Air Temperature is less than or equal to the Return Air Temperature Set point minus  $\frac{1}{2}$  of the Return Air Temperature Band Set Point, the Heating Demand shall be 100%.

Heaters are then staged based on Heater Start and Hysteresis Set points. Each heater starts when the Heating Demand rises above its Start Set point plus the Hysteresis Set point. Each heater stops when the Heater Demand falls below its Start Set point minus the Hysteresis Set point. The Start and Hysteresis Set points are based on the maximum number of heaters enabled.

**Example:** In a two-stage heater system, the Start Set point for Heater 1 is 33.3% and the Hysteresis Set point is 33.0%. Heater 1 energizes when the Heating Demand rises above 66.3% and stops at 0.3%. These Start and Hysteresis Set points are adjustable but it is not recommended unless consulting with United CoolAir’s support team first.

**Important:** Heating Start and End points also allow for a buffer around the Temperature Set Point to help prevent overshoot.

### Modulating Heat by Return Air Temperature

Modulating Heat by Return Air Temperature is based on the Heating Demand. This Heating Demand is calculated by the Return Air Temperature; Return Air Temperature Set point and Return Air Temperature Band Set Point. If the Return Air Temperature is less than or equal to the Return Air Temperature Set Point minus  $\frac{1}{2}$  of the Return Air Temperature Band Set Point, the Heating Demand shall be 100%.

The amount of modulating heat applied parallels the Heating Demand. A total of 50% Heating Demand equals 5.0 vdc on the analog output controlling the Modulated Heating device.

**Important:** Heating Start and End points also allow for a buffer around the Set Point helping to prevent overshoot. These Start and Hysteresis Set points are adjustable but it is not recommended unless consulting with United CoolAir’s support team first.

### Heat Pump – Option

For systems with the Heat Pump option, Heat Pump mode is available for heating if the heat rejection type (air cooled or water cooled) temperature is above the Low Temperature Lockout Set Point (applies to both air and water cooled systems). United CoolAir strongly recommends Auxiliary Heaters for those systems located within geographical regions with inclement climates that heat pump mode will not always be available due to low ambient conditions. As a standard, the heat pump mode of operation shall operate down to low ambient lockout temperature. Once the Outdoor Temperature or Water Temperature is below the Low Temperature Lockout Set Point, the heat pump mode

will be locked out from operation until the temperature rises back above the Low Temperature Lockout Temperature Set Point plus the Low Temperature Lockout Temperature Band Set Point.

### **Heat Pump Option with Supplemental Heating (option)**

If the Heat Pump option was ordered with the Supplemental Heating Option, if the heat pump mode of operation is locked out due to the Temperature of the Outdoor Air or Water being colder than the Low Temperature Lockout Set Point, the Supplemental Heaters are Staged or Modulated to maintain the demand for Heating. As the Temperature of the Outdoor Air or Water rises above the Low Temperature Lockout Set Point plus the Low Temperature Lockout Band Set Point, the Supplemental Heaters are staged off or modulated down to allow the Heat Pump Mode to restart.

### **Defrost Cycle**

Heat Pump systems have a defrost cycle that performs defrost mode based on a temperature switches connected to the refrigerant lines of the outdoor coil of each compressor circuit. Should one of these switches close due to the temperature of the refrigerant line falling below the switches low temperature cutout set point, the compressors which are currently in operation will continue to remain on and the reversing valves will be energized to cycle cooling long enough to bring the temperature of the refrigerant line back above the Defrost Switches reset set point. Once the Defrost Switch(s) reset, the Reversing Valves are then de-energized placing the system back into heat pump mode of operation.

Should the system go into the defrost cycle and supplemental heating is available, the supplemental heaters are brought on to maintain the heating requirement.

### **Modulating Hot Gas Bypass for Lightly Loaded Compressor Management (option)**

Modulating Hot Gas Bypass for Lightly Loaded Compressor Management is an option used to false load the evaporator coil and compressor system during reduced loading conditions to the evaporator coil. Since the cooling demand has not been completely satisfied the compressor will continue to operate and the evaporator coil may start to freeze. The unit's controller regulates the amount of hot gas applied to the evaporator coil to prevent the evaporator coil from freezing based on the cooling demand.

As the Cooling Demand increases, compressors are staged ON based on the percentage of demand for each Compressor as well as the overall Cooling Demand. As the Cooling Demand decreases to a point where the demand for cooling required is less than the hot gas bypass start set point, Hot Gas shall be modulated through the electrically modulated Hot Gas Bypass Valve into the Evaporator Coil. If the cooling demand should then rise above the hot gas bypass start point, the Modulating Hot Gas Bypass will modulate closed and if the demand becomes high enough, Compressor(s) 2 and/or 3 will stage on.

### **Modulating Hot Gas Bypass by Supply Temperature (option)**

Modulating Hot Gas Bypass for Supply Air Temperature control is an option used to control the Supply Air Temperature as close to the Supply Air Temperature set point as possible. This option requires a factory provided Supply Air Temperature Sensor and a factory provided Modulating Hot Gas Bypass Valve. The Cooling Demand will increase or decrease based on the Discharge Air Temperature Set Point and Discharge Air Temperature Band Set Point. The compressors are then staged up/down based on Cooling and Compressor Demands. As the Supply Air Temperature falls below the Supply Air Temperature Set Point, the controller will modulate the hot gas bypass valve open to regulate the amount of hot gas to the evaporator coil in order to maintain the supply air temperature as close to the supply air temperature set point as possible.

If the Supply Air Temperature starts to increase, less hot gas will be required to maintain the Supply Air Temperature. At that point, the controller will modulate the hot gas valve closed as much as required to maintain the supply air temperature as close to the supply air temperature set point as possible. Likewise if the load in the space starts to decrease, the supply air temperature may start to decrease. At that point, the modulating hot gas valve will be modulated open again to maintain the supply air temperature at or as close to the supply air temperature set point as possible.

### **Dehumidification Mode (option)**

If the Room/Return Air Humidity is above the Room/Return Humidity Set point plus  $\frac{1}{2}$  the Room/Return Air Humidity Band Set point, the dehumidification demand will be 100%. The Demand for Dehumidification is placed into the Cooling Demand in order to stage the compressors ON/OFF based on each Compressor's Start and Hysteresis Set points.

### **Dehumidification plus Reheat Mode (option)**

If the Room/Return Air Humidity is above the Room/Return Humidity set point plus  $\frac{1}{2}$  the band set point, the dehumidification demand will be 100% and the compressor(s) will energize for dehumidification.

If the Room/Return Air Temperature falls below the Room/Return Air Temperature Set Point minus  $\frac{1}{2}$  the band set point during dehumidification, the heating demand will become 100%. The compressor(s) will continue operating and reheat will stage on/off or modulate to satisfy the optional reheat function. The reheat type could be Hot Gas Reheat, Electric Reheat, or a Hot Water or Steam Coil.

### **Humidification (option)**

Each system with the Humidification option will have a Modulating Humidifier controlled through the controller via Modbus Communications. Humidification is based on the Humidification Demand. The Humidification Demand is based on Room/Return Air Humidity, Room/Return Air Humidity Set Point, and Room/Return Air Humidity Band Set point. The Humidification Demand shall be 100% when the Room/Return Air Humidity is equal to or greater than the Room/Return Humidity Set point plus  $\frac{1}{2}$  of the Room/Return Air Humidity Band Set Point.

### **Unoccupied Mode**

During Unoccupied Mode, all outputs are de-energized. The Supply Air Blower has an option to operate continuously during the unoccupied period. The system also has the capability for both a Night Set Up and a Night Set Back function to maintain minimum temperature and humidity settings during the unoccupied mode. These Temperature and Humidity Set Points are located under the Unoccupied Control menu. Temperature and/or Humidity Control are based on the options ordered with the equipment. For instance in order to maintain a Return Air Temperature Set Point of greater than 60 degrees Return Air Temperature, when the temperature falls below 60 degrees, the system will require some form of heating option.

### **Unoccupied Override**

There are three methods of Unoccupied Override that may be utilized to override the Unoccupied Mode, temporarily starting the unit to continue the conditioning process. The methods for Unoccupied Override are initiated 1) by User Interface, 2) by Digital Input, or 3) by BMS point interlock. The system will accept all three methods for Unoccupied Override mode so if connected to either a digital input or a BMS system, Unoccupied Override can be initiated from any of the three methods.

### **Unoccupied Override by User Interface**

The User Interface has an Unoccupied Override trigger built in on the last page of the main System Status screens. Simply press the Up Arrow button one time to get to this page quickly then enable the Override to the ON position. Set the Unoccupied Override timeout time for the system to go back into Unoccupied Mode. Press the Enter button to drop the cursor under the Override Time and change it to the desired Override Time by pressing the UP/DOWN buttons. Press the Enter button to initiate the time into memory. The cursor will now be at the Override ON/OFF point. Press the UP/DOWN buttons to set Override to ON and then press the Enter button. Unoccupied Override will start and follow the Override Timeout Time. To reset the Override Time, simply move the cursor back to the Override ON/OFF point and set the field to the Reset position and press enter which will send the unit back into Unoccupied mode.

### **Unoccupied Override by Digital Input**

**(Requires available digital input and a voltage free dry contact closure momentary push button)**

A digital input can be set up to receive a momentary pushbutton contact closure to initiate the start period of the Unoccupied Override function. The Unoccupied Time period will follow the time that is set into the wall display just as it would by initiating it at the wall controller.

### **Unoccupied Override by BMS (Requires the BMS Communications option)**

A BMS Point is available and requires the BMS Option to initiate the Unoccupied Override function. The time period for Unoccupied Override mode is also adjustable through BMS. Simply set the unoccupied override time period in minutes. Then Enable/Disable the Unoccupied Override point to start the Unoccupied Override process. If terminating Unoccupied Override before time expiration is desired then a reset point is also available.

### **NOTE:**

#### **Control of Heaters**

If the system has staged heaters, there will be a Morning Warm-Up ON Temperature Set point and a Morning Warm-Up OFF Temperature Set point. If the system has modulating type heaters, the amount of modulation is based the Morning Warm-Up Return Air Temperature Set point and Morning Warm-Up Return Air Temperature Band Set point.

## Morning Cool-Down

Morning Cool-Down is a function typically found in Variable Air Volume applications. There are numerous methods of enabling the Morning Cool-Down function. The three basic methods available through the controller are:

1. By Time
2. By BMS Communications (Building Management System)

### Morning Cool-Down by Time

When selected to Morning Cool-Down by Time, the Cool-Down Schedule is located and setup under the Schedule menu. The Morning Cool-Down Set Points are adjusted through the Set Points menu. Cool-Down should be scheduled to operate during the Unoccupied Mode just before the start of the occupied day. Morning Cool-Down shall start the cooling cycle and cool until either the Return Air Temperature falls below the Morning Cool-Down Set point or the Morning Cool-Down period expires. Once this occurs, the start of the occupied day becomes active.

### Morning Cool-Down by BMS

(Requires BMS Communications option)

Should the controller have the BMS option, Morning Cool-Down by BMS can be enabled. Morning Cool-Down by BMS simply enables the Morning Cool-Down Mode when the BMS point for Morning Cool-Down is enabled ON. Once active, the Morning Cool-Down Mode will start the cooling process based on the Morning Cool-Down Set points located under the Set Points menu. These set points are also adjustable via BMS points.

### Remote Start/Stop

Remote Start/Stop is a standard feature with all units. The Remote Start/Stop feature allows customers to tie in a field provided external Voltage Free Dry Contact Switch to Remotely Start and Stop the unit based on their own time of day schedule.

### Global Alarm

As a standard, Interlock Terminal Blocks are provided for field connection to the Global Alarm dry contact closure output. Should the unit go into an alarm condition on any of the following items listed below, a relay will be energized to provide a dry contact closure to control a field provided alarm buzzer or indicator light to alert the customer of the alarm condition with the unit. The power required to drive

the field provided device shall be 24VAC powering a device of less than 3 amps maximum through the factory provided relay.

- Loss of Airflow
- Drain Pan Overflow
- Dirty Air Filter
- Heater High Limit
- Damper Failed to Open
- Fan Motor Overload
- High Duct Pressure
- Water Flow
- Fire/Smoke Detected
- Freeze Stat Alarm (with Freeze Stat option)
- Compressor High and Low Pressure
- Sensor Failure
- Temperature High or Low Alarms
- Humidity High or Low Alarms

## STANDARD SYSTEM SAFETIES

### Proof of Airflow (Air Flow Switch)

Each system has a switch to monitor for loss of airflow. The output for the Supply Air Blower must be energized for a minimum 60 seconds (field adjustable) before any modes of operation are enabled. Should the airflow switch remain open after the time delay expires or the airflow switch opens while any system modes are in operation, the system shuts down the modes of operation and the supply air blower and provides a loss of airflow alarm.

### Fire/Smoke Detection

The Fire/Smoke Detection shut down is a factory standard feature (electrical termination points only). This Fire/Smoke Detector can either be factory provided as an option or field provided. The electrical termination points require a voltage free (dry) normally closed (opens on alarm) contact which must be connected to the factory provided terminal blocks. If the Fire/Smoke Detector is factory provided, the detector will be shipped loose for field installation.

If the Fire Stat/Smoke Detector goes into alarm, the normally closed contact opens, all functions of the system will be shut down, and the controller will provide a Fire/Smoke Alarm.



The system will reset based on the setup for reset of the Fire/Smoke Alarm. There are two types of reset for a Fire/Smoke Alarm “Automatic or Manual”.

Automatic reset will automatically reset and restart the system without resetting the audible or visual alarm so the customer knows when the unit tripped on a Fire Stat/Smoke Detector Alarm. Manual reset requires the customer to manually reset the Fire Stat/Smoke Alarm condition before the unit will restart the functions of the system. The default setup for Fire/Smoke Alarm is to lock the system out from operation requiring a manual reset/restart at the unit’s Interface Controller. The field has the ability to set the unit to auto-reset/auto-restart once the Fire/Smoke Alarm resets.

### **Compressor High Pressure Switch**

Each Compressor is protected with a high pressure cutout switch. The switch may vary in pressure range based on the type of refrigerant within the refrigerant circuit. For ON/OFF Type Compressors, the high-pressure switch is wired in series with the digital output that controls the ON/OFF function of the corresponding compressor.

For instance Compressor 1 High Pressure switch connected to Digital Output 2 will start and stop Compressor 1 by whether the switch is open or closed. The High-pressure switch will open if the refrigerant pressure is greater than the refrigerant pressure set point. The open Compressor 1 High Pressure Switch will de-energize the relay that energizes and de-energizes the Compressor 1 Contactor. One contact energizes and de-energizes the compressor contactor and the other relay contact sends the alarm signal back to the controller to let the control know that Compressor 1 High Pressure switch tripped. The high-pressure switch will take the compressor offline as it is wired to the relay that controls the contactor for the compressor but it will also allow the relay to provide the alarm signal.

Once the High Pressure Trip occurs, the compressor must be re-enabled under the System Enables menu in the controller.

**NOTE: R410A Refrigerant Systems also require a manual reset of the switch due to higher operating pressures within the system.**

### **Compressor Low Pressure Switch**

Each Compressor is protected by a Low Pressure cutout switch. The switch may vary in pressure range based on the type of refrigerant within the refrigerant circuit. Unlike the high-pressure switch, the low-pressure switch is connected directly to a digital input on the controller. Should the Low Pressure Switch open during a compressor run cycle, the corresponding compressor will trip on low-pressure safety. If this occurs, the controller will de-energize the corresponding digital output to the compressor contactor.

Once the Low Pressure Trip occurs, the compressor must be manually re-enabled under the System Enables menu in the controller. The low-pressure switches automatically reset once the pressure at switch rises above the switches reset point.

### **Heater High Temperature Cutout**

Factory provided heating banks are supplied with a heater high temperature cutout switch that trips as the surrounding air temperature at the switch causes the temperature on the switch to rise above the cutout point. The switch is bimetallic auto reset type. Should the switch trip; an alarm will be displayed on the controller alerting the customer to Heater High Temperature Cutout. If a heater high temperature cutout occurs, the heaters automatically restart once the surrounding air temperature cools the surface of the switch enough to allow the switch to reset.

### **Sensor Failure**

There are two methods for sensor failure. One method is when the reading is above or below minimum and maximum range of the sensor. With this method, the sensor should be displaying a value on the display of the controller. The other method is a mis-wired or sensor that simply was not installed during installation. This method will display a ###.# output for the failed sensor on the wall controller along with the label of the sensor.

### **High and Low Limit Alarms**

Each controller has adjustability for High and Low set point alarms for the following sensors. The High and Low Limit Set Points are available under the Alarm Set Points menu. The sensors must be enabled for the High and Low Alarm Set Point display screens to appear. The following sensors have high and low alarm set point capability:

- Return Air Temperature
- Return Air Humidity
- Supply Air Temperature
- Duct Pressure
- Room Pressure
- Refrigerant Pressure
- Room Temperature
- Room Humidity
- Space Temperature
- Space Humidity

## OPTIONAL SYSTEM SAFETIES

### Outdoor Air Damper End Switch

If the field provided Outdoor Air Damper Actuator has a Damper End Switch, the Damper End Switch could be connected to the unit's controller for Alarm notification and shut down if the outdoor air damper does not open. The damper and damper actuator must be field installed and wired back to the optional factory terminal blocks for the Outdoor Damper End Switch option.

If the actuator fails to drive the damper open, an alarm notification will alert the customer of the damper actuator failure and the system is locked out from operation. There is a delay for the contact closure that should allow ample time for the actuator to drive completely open. This time delay has a factory default of 3 minutes. Please refer to the Factory Settings section for details on adjusting this time delay. Once the problem is corrected, the system must be manually reset through the controller's user interface.

### Drain Pan Overflow Switch

The drain pan overflow switch is an optional factory supplied component. The drain pan overflow switch is water level detection switch that opens when the water level is too high in the unit's drain pan indicating that the condensate drain may be blocked. If there is a blockage in the condensate line, the rising water level in the condensate drain pan will open the drain pan switch creating an alarm at the controller. The drain pan overflow switch shuts down cooling preventing

the condensate from overflowing the drain pan. The alarm will notify the customer of the drain pan overflow condition. Once the blockage is removed from the condensate drain line, the system must be manually reset at the controller's user interface.

### Dirty Filter Switch

The dirty filter switch is an optional factory supplied component. When the air filter becomes dirty and should be replaced, the contacts on the filter switch will open causing an alarm at the controller. The alarm will be in the form of a notification recommending that the air filter be changed for preventive maintenance. The system will continue to run in its current mode of operation. The alarm notification can be reset through the units user interface.

### Freeze Stat (Compressor)

If the Compressor Freeze Stat option is ordered, the freeze stat switch is factory provided, factory installed and wired to the unit's controller. If the temperature of the evaporator coil falls below the temperature set point of the freeze stat, the switch contacts open to the controller providing an alarm and the controller shuts down the cooling mode of operation.

The Freeze Stat switch automatically resets once the temperature of the evaporator coil rises above the reset temperature set point of the switch.

The system will reset based on the controller's setup for reset of the Freeze Stat Alarm. The controller's set-up for reset to the Freeze Stat Alarm is selectable for either automatic reset or manual reset. As a standard, cooling mode restarts to provide cooling. The controller will retain the alarm to alert the customer of the coil freezing condition and that the system should be checked by a technician to ensure proper operation of the cooling cycle.

Automatic reset will automatically reset and restart cooling mode without resetting the audible or visual alarm so the customer knows when the unit tripped on Freeze Stat. Cooling will automatically restart once the Temperature on the Freezestat rises above the Freeze stat's reset temperature setting. Manual reset requires the customer to manually reset the Freeze Stat Alarm condition before the unit will restart the functions of the system.

### Freeze Stat (Hot Water/Steam Preheating Coil)

If the Hot Water/Steam Coil Freeze Stat option is ordered, the freeze stat switch is factory provided, factory installed and wired to the unit's controller. If the temperature freeze stat falls below the Freeze Stat Set point, the Freeze Stat sends the system into a Freeze Protection Mode.

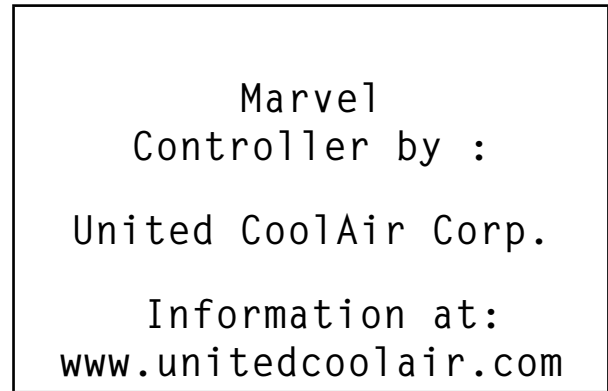
The output to the Hot Water/Steam Coil will drive the valve completely open to send full flow through the coil to assist with freeze protection. All of the system outputs will be de-energized to prevent operation of the system while preheat is not available and all modes of operation are shut down. A Freeze Protection Active alarm will appear on the display of the controller to alert the customer of the freeze condition and that the system requires service.

### Water Flow Switch (option)

This option prevents compressors from operating on Water Cooled units when there is no water flow. Factory provided dry contacts are provided for a field provided field installed water flow switch. If there is no water flow after the alarm time delay time out an alarm notification shall be provided and the compressors will remain off until water flow is restored. This is only a notification type alarm and the compressors will automatically restart once water flow is restored to the unit. The alarm notification can be reset at the controller or by optional BMS.

### Marvel Terminal Keypad and Display Operation

This section is provided as a guide to explain the functions of each of the display screens associated with the operation of the unit. Upon application of power, there will be two screens called splash screens identifying United CoolAir with a Logo (not pictured) then transferring it to the name of the controller being developed by United CoolAir Corporation as well as information for further reference.



### Controller Operation

#### Up Button ↑


The ↑ button is used to scroll upward through status screens, menus, sub-menus and change the value of parameters or settings.

#### Alarm Button 🔔 (Alarms and Resetting)

When an Alarm occurs, an audible alarm buzzer will sound off to alert the customer of the alarm condition. The LED indicator inside the 🔔 button will illuminate flashing on and off Red. Present Alarms are displayed in English text in order of occurrence. Press the 🔔 button one time to display the present and most recent alarm condition. Press the ↓ button to display all remaining alarms that may be present. When the 🔔 button is pressed one time, the audible alarm will silence. In an alarm condition, the appropriate system's stage or mode of operation is shut down preventing the particular stage or mode from operation to protect it. Once repairs are made to the particular mode or stage, pressing the 🔔 button and then pressing the ↓ button until the screen Press ALARM for 3 seconds appears and then physically pressing and holding the 🔔 button will clear the alarm. The Red LED inside the 🔔 button will disappear.

For example, if the low pressure switch for Compressor 1 opens due to a low refrigerant pressure condition, Compressor 1 Low Pressure will be displayed when the 🔔 button is pressed. Compressor 1 will be shut down and locked out from operation until repairs are made to Compressor 1's refrigerant system.


**DANGER:** BEFORE ATTEMPTING TO TROUBLESHOOT A SYSTEM ALARM, BE AWARE THAT REFRIGERANT CONTAINED IN EACH COMPRESSOR SYSTEM AND HOT WATER OR STEAM FROM HEATING COILS CAN CAUSE SEVERE BURNS. HIGH VOLTAGE AND OPERATING FAN DRIVES ALSO PRESENT HAZARDOUS CONDITIONS. BE AWARE OF THE DANGERS AND CONTACT APPROPRIATE PERSONNEL OR CERTIFIED TECHNICIANS TO SERVICE THE EQUIPMENT.

Pressing the  alarm button enters the Alarms menu. If there is an Alarm present, the displayed Alarm will look similar to this example showing time and date of occurrence. Press the

```

Alarms 0 1 / 0 1
      15:35 04/05/17

Comp 1 Low Pressure
  
```

If there are no present alarms the NO ALARMS will be displayed. Pressing the  enter button with No Alarms present will enter the Alarm Log. The alarm log simply is a record of the alarms that occurred. A total of 64 previous alarms will be stored into memory. If there are no alarm logs present, the system will not enter the Alarm Logger. Press the Esc button to return to the main status loop

```

NO ALARMS





Press ENTER to
enter ALARM LOGS
  
```

```



Alarm Logger Record>01
                    15:35 04/05/17

Comp 2 Low Pressure
  
```

### Changing Set Points, Parameters, And Values

Set points, Parameters, and changeable values are known as Fields. Press the  enter button to move the cursor to the field for the desired change. Press the  (up) or  (down) button to change the value within that field, and then press the  enter button to save the change into memory.

### System Status

By default the system remains within the System Status menu loop if no one has accessed the unit for greater than five (5) minutes. Simply pressing the  (up) or  (down) buttons, scrolls through the available screens within the System Status menu. Each screen in the Status menu displays the operating conditions or Status of the system. Listed below are the Screens that will appear under System Status for particular setups based on application setup and available options.

```

U01  Mon 07:21 03/19/17

Return Hum >      55.0%
Return Temp>      74.7 °F
Supply Temp>      57.2 °F

One Compressor ON
  
```

This is the home screen within the System Status. If no buttons are pressed within 5 minutes, the displayed screen will revert back to this displayed screen showing Day of the

Week, Time of Day and Date. The main readings are also displayed here as well as operating status. The displayed readings may change based on system setup. For instance, if Space Temperature and Space Humidity are selected instead of Return Temperature and Return Humidity, then Space Hum and Space Temp will be displayed. If there are two supply temperature sensors installed, then Supply Temp Avg will be displayed on this page and both Supply Temperature 1 and Supply Temperature 2 will be displayed on another screen.

```

U01          Blower Status

Supply Blower>0N
Start Delay >000sec
Minimum Run >000sec
Stop Delay >030sec
Mode Start >060sec
Damper Delay>000sec
    
```

This screen displays information about the blower status and all of the time delays for the blower, Fresh Air Damper and Mode Start Delay. The Damper Delay is the time it takes for a Fresh Air Damper to open and will only be displayed if the damper actuator does not have an End Switch for proof that the damper is open. The Mode Start must time out before any modes of operation will occur. The start delay and damper delay take precedence so once the system is on, the start delay must time out and then the damper output is energized. Once the output for the damper is on for the length of the damper delay, then the blower output is energized. Once the blower is on for the length of the mode start delay, then the mode of operation (cooling, heating, humidification, or dehumidification) will start if required.

```

U01          Air Economizer

Econ Demand > 037.9%
Outdoor Temp> 45.7 °F
Outdoor Hum > 48.2%
Enthalpies:
  Outdoor>22.3btu/ lb
  Indoor >29.3btu/lb
    
```

Depending on the type of Air Economizer setup, the information displayed on this screen may appear like this or with less information. The output voltage to the actuators will be the air economizer demand divided by 10 so from the displayed value, the Analog Output voltage to the damper actuators will be 3.79 vdc. A damper minimum and maximum output can also be added under Economizer Setup within the Technician Menu which will be discussed later in this manual. When set up as Enthalpy Type, the Outdoor Air Enthalpy must be less than the Indoor Air Enthalpy and the Outdoor Air Temperature must be less than the Outdoor Temperature Set Point for Air Economizer for the system to go into air economizer mode of operation. The Econ Demand will match the Cooling Demand. If a Minimum Damper position set point is added, the dampers will always maintain that position when the system is on and in occupied or set back mode and they will be closed when the system is off or unoccupied.

```

U01          Cooling Status

Demand> 067.2%
Compressor 1 >0N
    
```

This screen shows the demand for Mechanical Cooling Compressors and total number of compressors in operation.

```
U01   Stage Start Delay
Compressor 1>000sec
```

This screen will only appear if the head pressure control water valve option is installed on water cooled units and if there is a Demand for cooling on the Cooling Status page otherwise this screen is hidden until there is again a demand for cooling.

```
U01           Minimum ON
Compressor 1>000sec
```

This screen displays the minimum run time required for the compressor. The default is 120 seconds of Run Time. Once the time delay returns to 0 seconds, and if there is no requirement for each particular compressor to be on, the compressor will turn off. Should there be a requirement for the compressor to turn off due to the demand decreasing too rapidly, the compressor must remain on the minimum on time before it can turn off. Typically if something like this occurs where a compressor turns on and then immediately, there is no longer a demand for that particular compressor to run, it indicates that the Proportional Band of the Set Point should be adjusted to prevent short cycling of the compressor(s).

Any alarms that occur within compressor circuits will bypass the minimum on time(s) for the particular compressor with the alarm. This screen only appears if there is a Demand for cooling on the Cooling Status page otherwise this screen is hidden until there is again a demand for cooling.

```
U01           Minimum OFF
Compressor 1>000sec
```

The minimum off time is the amount of time before the particular compressor that has a time greater than zero can restart. This screen only appears if there is a Demand for cooling on the Cooling Status page or the Minimum OFF Delay of one of the compressors is greater than zero, otherwise this screen is hidden until there is again a demand for cooling.

```
U01           Liquid Pressure
Liquid Pres 1> 311psi
```

The Head Pressure/Liquid Pressure control screen shows the liquid pressure for the compressor stage with water cooled units having the Electronic Head Pressure Control option. The default Discharge Pressure Set Point is 325 psig.

```

U01      Analog Outputs

Mod Heating    > 9.6v
Air Econo     > 0.0v
  
```

The Analog Outputs screen displays information about the modulating outputs to control modulated devices. Presently the Marvel controller controls the any of the devices listed within the Analog Output list shown on page 4. Please inquire with a United CoolAir local distributor for additional options desired.

```

U01      Unoccupied
          Override

Duration>000090min
Elapsed >000025min
Override>On
  
```

The Unoccupied Override screen displays the following information and settings. Duration is the time in minutes for to unit to continue to run when it is supposed to be unoccupied. The unit continues to run in the Occupied state during the override time until the Unoccupied Override "Duration" time has "Elapsed". So the Elapsed time is the amount of time that has passed with the unit operating in the

Unoccupied Override period. The Override On/Off/Reset is the setting is the enable point to start or stop the Override time. Once the Override Duration has Elapsed, the Override On returns to Off automatically. Should the occupant(s) wish to vacate before the Override time has elapsed, the Override setting can be set to the Reset position which automatically terminate the Override Duration time and returns the unit to the Unoccupied state.

### Main Menu System

The Main Menu is the menu system used to navigate through the controller's statuses and settings. The following Menu items are available within the Main Menu System: System ON/OFF, System Status (previously documented), System Enables, Set Points, Alarm Set Points, Run Hours, Day Min/Max, Clock Settings, Schedule, Setback, Unocc Control, Change Passwords, Technician Menu, and Factory Menu.

Simply pressing the **↑** (up) or **↓** (down) buttons, scrolls through the available screens within the System Status menu. Press the **↵** (enter) button to enter any of the Sub-Menus listed in the Main Menu. Press the Esc (escape) button to return to the System Status loop.

```

Main Menu 01

>>>System ON/OFF <<<

↵ / ↵ Scroll Up/Down
↵ Enter Selected Menu
Esc to Previous
  
```

Enter into the System ON/OFF to turn the unit ON/OFF Switch to the ON or OFF position.

```

Main Menu 02

>>>System Status <<<

↵ / ↵ Scroll Up/Down
↵ Enter Selected Menu
Esc to Previous
    
```

The System Status can be entered either by pressing the enter button while this main menu item is displayed or by continuing to press the escape button.

```

Main Menu 04

>>>Set Points <<<

↵ / ↵ Scroll Up/Down
↵ Enter Selected Menu
Esc to Previous
    
```

The Set Points sub-menu is used to change any changeable set point other than Alarm Set Points.

```

Main Menu 03

>>>System Enables <<<

↵ / ↵ Scroll Up/Down
↵ Enter Selected Menu
Esc to Previous
    
```

The System Enables is used to Enable or Disable Compressors, Heaters, Humidification, and Dehumidification. It is also used to re-enable compressors after a Compressor Safety (high pressure, low pressure, digital compressor module alarm) has disabled a compressor.

```

Main Menu 05

>>>Alarm Set Points <<<

↵ / ↵ Scroll Up/Down
↵ Enter Selected Menu
Esc to Previous
    
```

Likewise the Alarm Set Points menu only has Set Points for Alarming Functions. There are no regular set points in this sub-menu.


```

Main Menu 06

>>>Run Hours <<<

↵ / ↵ Scroll Up/Down
↵ Enter Selected Menu
Esc to Previous
    
```



The Run Hours sub-menu displays the total amount of run hours for each component. The hours counter for each component is resettable if that particular component has been replaced. Press the enter button to move the cursor next to the hours then press up or down to set the function to R for Reset. **CAUTION:** Do not press the  enter button when R appears unless there is truly a need to reset the hours counter of a component, otherwise the Reset is almost instantaneous and cannot be stopped.

```

Main Menu 07

>>>Day Min/Max <<<

↵ / ↵ Scroll Up/Down
↵ Enter Selected Menu
Esc to Previous
  
```

The Day Min/Max sub-menu records the highest and lowest Temperatures for Return/Space Temperature and highest and lowest humidity for Return/Space Humidity (if humidity sensor is installed) over a 24 hour period.

```

Main Menu 08

>>>Clock Settings <<<

↵ / ↵ Scroll Up/Down
↵ Enter Selected Menu
Esc to Previous
  
```

The Clock Settings sub-menu allows the customer to adjust time zone, time of day, day of the week, and date.

```

Main Menu 09

>>>Schedule <<<

↵ / ↵ Scroll Up/Down
↵ Enter Selected Menu
Esc to Previous
  
```

The Schedule sub-menus allows customer to configure an Occupancy Schedule for their system.

```

Main Menu 10

>>>Setback <<<

↵ / ↵ Scroll Up/Down
↵ Enter Selected Menu
Esc to Previous
  
```

The Setback sub-menu allows customers to set their Set-Back schedule so that if full operation is not required, the system can be placed into a Set-Back mode to increase/decrease the Set Point values to the Set Point Values listed in the Set-Back sub-menu. Set-Back assists with saving energy as it reduces load on the system. During Set Back mode, any interconnected Outdoor Air Dampers remain open until the system goes into Unoccupied mode.

```

Main Menu 11

>>>Unocc Control <<<

↵ / ↵ Scroll Up/Down
↵ Enter Selected Menu
Esc to Previous
  
```

Unoccupied Control is similar to the Set-Back control with the exception that any interconnected Outdoor Air Damper will close. Typically the Unoccupied Control Set Points are reduced even further to lighten the load on the system even further to assist with saving energy.

```

Main Menu 13

>>>Technician Menu <<<

↵ / ↵ Scroll Up/Down
↵ Enter Selected Menu
Esc to Previous
  
```

The Technician Menu sub-menu allows Technicians to access the following sub-menus: Fan Settings, System Units (Unit of Measure), Network (sets up network units), Manual Control, Sensor Setup, Digital Inputs, Economizer, Blower VFDs, Change Passwords, and Information. The Technician Menu password is 9995. Once the password is installed, the sub-menu will remain actively open until a button has not been pressed for five (5) minutes. After five minutes, the password must be reinserted.

```

Main Menu 12

>>>Change Passwords <<<

↵ / ↵ Scroll Up/Down
↵ Enter Selected Menu
Esc to Previous
  
```

The Change Passwords sub-menu allows customers to install a Basic Password to lock out portions of the Main Menu that have adjustable settings. Read Only variables with the Main Menu sub-menus can still be displayed without requiring a password.

```

Main Menu 14

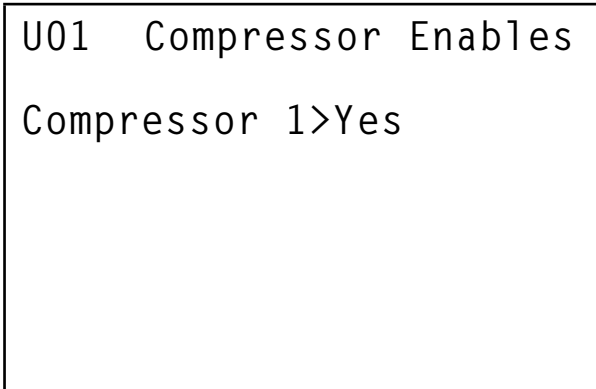
>>>Factory Menu <<<

↵ / ↵ Scroll Up/Down
↵ Enter Selected Menu
Esc to Previous
  
```

The Factory Menu sub-menu is the application parameters setup area. Please consult United CoolAir Technical Services Department before making any changes within this sub-menu.

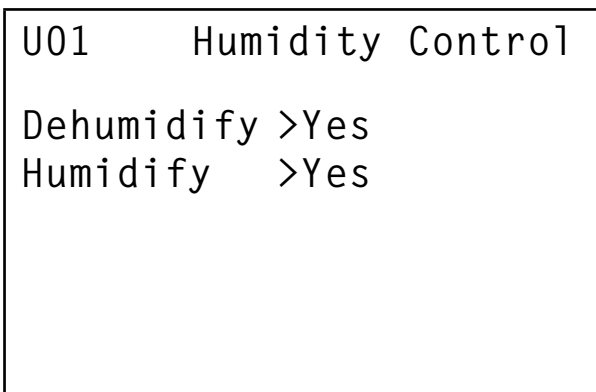
## SYSTEM ENABLES

This sub-menus allows for enabling and disabling of main system components.

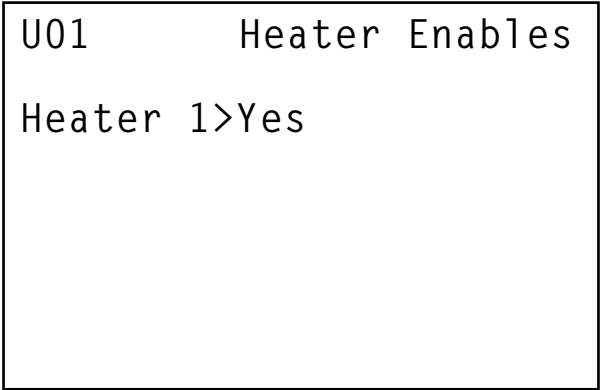


Compressor Enables allows for Enabling and Disabling of installed compressors. Compressor Enables will only appear up to the maximum compressors installed. If a Compressor Fails on High or Low Pressure or a Digital Compressor Fails on a Module Alarm, the Compressor will be disabled. This is the screen that the compressor must be re-enabled to allow the compressor to restart. If a compressor trips on safety, the compressor must be re-enable on this screen to restart the compressor that tripped.

**IMPORTANT:** If a compressor tripped on safety, it must be re-enabled before the alarm can be cleared.



The Humidity Control Enable screen allows for systems that have a humidity sensor installed to enable or disable dehumidification. Also if a humidifier is installed, it allows for enabling and disabling of humidification.



The Heater Enables screens allows for enabling and disabling of heater banks. The amount of heaters displayed on the screen will be up to the total amount of heaters installed.

## SET POINTS

The following Set Point Screens are available based on how the system is set up and type of sensors installed. Unlike in the past where customers only had a single set point available, the Marvel Controller allows for either a single control Temperature Set Point and single control Humidity Set Point or separate control set points for Temperature and Humidity. The standard will be separated set point control. This will be clear in the Set Points sub-menu by seeing the Cool Set Point and Heat Set Point as well as if a humidity sensor is installed, there will be a Dehumidify Set Point and a Humidify Set Point (only if the Humidifier option is installed).

### Explanation of Set Point Screens:

**Set Point** Set Point is the desired setting that the customer would like the unit function to maintain for specific comfort level.

**Prop Band** Prop Band is the proportional band setting that over the range of demand 0 to 100% for the function (cooling, heating, dehumidification, humidification, etc.). Example of the Proportional Band: For the Return Cooling Set Point with a Set Point of 72.0°F and a Proportional Band of 5.0°F, the Cooling Demand will be 100% when the Temperature is at 77.0°F. It will be 50% Cooling Demand at 74.5 degree.

Unlike previous Marvel Controllers, the Marvel now uses this Proportional Band as total band vs in the past having to divide the band in two and adding or subtracting it from the Set Point. This meant the demand was 100% at ½ of the proportional band.

**Dead Band** Dead Band is the region of comfort level that is acceptable and no output adjustment to the Demand for (Cooling, Heating, Dehumidification, Humidification, etc.) is required. Setting this to zero means that the controller will continue to output a demand till the Demand required meets the set point.

**IMPORTANT:** Systems may have Proportional and Integral control set up within a Set Points function block. Each of the settings above is input to a PID Function Block. Should the Set Point method be set up with a value installed in the Integral setting, the specific function block of the Set Points that have a value greater than zero set in the Integral set point will continue to increase or decrease the demand output in an effort to maintain the exact set point value. Should a Dead Band setting have a value installed, the output adjustment will remain the same and no updates applied within the Dead Band region above or below the set point. Should the Dead Band setting be a value of 0.0, the output demand shall continue to increase or decrease in an effort to maintain the exact set point value.

**NOTE:** Though the separate set points are adjustable, there is a built set point buffer to auto increase or decrease the opposite set point to prevent simultaneous Cooling and Heating or Humidification and Dehumidification.

**CHANGING SET POINTS**

To change a Set Points, press the ← enter button to move the cursor to the field of the desired set point change. Press the ↑ (up) or ↓ (down) buttons to change the present value of the set point to the newly desired set point. Press the ← enter button to save the change into memory.

U01	Return Cooling Set Points
Setpoint >	73.0 °F
Prop Band>	5.0 °F
Dead Band>	1.0 °F

U01	Return Heating Set Points
Setpoint >	68.0 °F
Prop Band>	2.0 °F
Dead Band>	0.0 °F

U01	Return Dehumidify Set Points
Setpoint >	50.0%
Prop Band>	4.0%
Dead Band>	2.0%

U01	Return Humidify Set Points
Setpoint >	45.0%
Prop Band>	4.0%
Dead Band>	2.0%

The above Set Point screens are available with a duct mount Return Temperature and Humidity Sensor. Return Heating Set Points will only appear if heaters are enabled under Factory Menu. Return Dehumidify Set Points will only appear if a duct mount Return Humidity Sensor is installed and Dehumidify is enabled. Return Humidify Set Points will only appear if a duct mount Return Humidity Sensor is installed as well as the Humidifier option and Humidify is enabled.

U01	Space Cooling Set Points
Setpoint >	73.0 °F
Prop Band>	5.0 °F
Dead Band>	1.0 °F

U01	Space Dehumidify Set Points
Setpoint >	50.0%
Prop Band>	4.0%
Dead Band>	2.0%

The above Set Point screens are available with a wall mount Space Temperature and Humidity Sensor. Space Heating Set Points will only appear if heaters are enabled

under Factory Menu. Space Dehumidify Set Points will only appear if a wall mount Space Humidity Sensor is installed and Dehumidify is enabled. Space Humidify Set Points will only appear if a wall mount Space Humidity Sensor is installed as well as the Humidifier option and Humidify is enabled.

In variable air volume applications in the past with heat pump or cooling/heating applications, it was required to enable a variable for Cool/Heat option for an automatic cooling and heating unit changeover. This placed the Cooling or Heating mode independently on the Return Air Temperature to make the determination of Cooling/Heating mode based on being above or below the Return Air Temperature Set Point. The system then controlled the amount of stages for cooling or heating by the Supply Cooling and Heating Set Points.

This is no longer the case as now the system will work as follows: Should the Heating Set Point remain less than the Cooling Set point, Heating will heat the supply air temperature back to set point and allow the individual VAV Terminal outlet boxes with their own field supplied heaters bring the air temperature of the tenant occupied zone back up to the set point required. Should the Supply Heating Set Point be increased above the Supply Cooling Set Point, the previously mention Cool/Heat enable point is automatically enabled. Once the Supply Heat Set Point is increased above the Supply Cool Set Point, the system then looks to Cool or Heat based on the Return Air Temperature being above or below the Return Cool or Return Heat Set Points. Once the determination is made by the Return Temperature and Return Temperature Cooling and Heating Set Points, The amount of stage applied are based on the Demand for Cooling or Heating by the Supply Cooling and Supply Heating Set Points and Prop Band settings.

If the system does not have heaters, only Supply Cooling Set Points will appear.

U01	Air Economizer Set Points
Outdoor Temperature:	
Setpoint >	60.0 °F
Band >	5.0 °F

U01	Water Economizer Set Points
Return Temp >	76.0 °F
Water Temp >	66.0 °F
Differential >	5.0 °F

U01	Space Temperature Set Points
Setpoint >	73.0 °F
Prop Band >	2.0 °F
Dead Band >	0.0 °F

The Air Economizer and Water Economizer Set Point screens are used to change the activation points of Airside Economizer and Waterside Economizer operation.

For Air Economizer, the Outdoor Air Temperature must fall below the Outdoor Temperature Set Point minus the band Set Point before Airside Economizer will start. Once in Airside Economizer, as long as there is a demand for cooling or the Outdoor Air Temperature is above the Outdoor Temperature Set point plus the Band Set Point or if the Outdoor Air Enthalpy is worse than the Indoor Air Enthalpy (depending on type of Air Economizer setup) the system will remain in Air Economizer mode of operation. See Airside Economizer sequence for full explanation of operation.

For Water Economizer, the Water Temperature entering the unit must be less than the Return Air Temperature minus the Differential Set Point. If the entering water temperature is greater than the Return Air Temperature minus the differential, the system will only use the Mechanical Cooling Compressors to satisfy the cooling demand.

U01	Return Humidity Set Points
Setpoint >	50.0%
Prop Band >	10.0%
Dead Band >	2.0%

U01	Space Humidity Set Points
Setpoint >	50.0%
Prop Band >	4.0%
Dead Band >	2.0%

U01	Return Temperature Set Points
Setpoint >	73.0 °F
Prop Band >	5.0 °F
Dead Band >	1.0 °F

As discussed previously, the system could be set up to use single set points to control both cooling and heating modes or dehumidification and humidification. Shown above, the system will be at 100% Cooling Demand when the Return Temperature is greater than the Return Temperature Set Point plus the Prop Band setting. The system will be at 100% Heating Demand when the Return Temperature is less than the Return Temperature Set Point minus the Prop

Band setting. Shown above, the system will be at 100% Dehumidification Demand when the Return Humidity is greater than the Return Humidity Set Point plus the Prop Band setting. The system will be at 100% Humidification Demand when the Return Humidity is less than the Return Humidity Set Point minus the Prop Band setting.

The Space Temperature and Space Humidity Set Point screens work the exact same as the Return Temperature and Return Humidity screens. The only difference is type of sensor installed Return is duct mount and Space is wall mount. The other difference is terminology.

### ALARM SET POINTS

```

U01  Return Temperature
      Alarm Set Points

High Setpoint > 85.0 °F
Low Setpoint  > 60.0 °F
Enable High   > Yes
Enable Low    > No
Alarm Delay   > 060sec
    
```

```

U01  Space Temperature
      Alarm Set Points

High Setpoint > 85.0 °F
Low Setpoint  > 60.0 °F
Enable High   > Yes
Enable Low    > No
Alarm Delay   > 060sec
    
```

Depending on the setup, Return Temperature or Space Temperature, there are specific High and Low Alarm Set

Points both having enable points for high and low alarm. The Enable High and/or Enable Low must be set to Yes in order to the High and/or Low Alarm to trigger when the temperature rises above or falls below the Alarm Set Point. The Temperature must also remain above or below the Alarm Set Point for the Alarm Delay before the Alarm will occur.

```

U01  Return Humidity
      Alarm Set Points

High Setpoint > 60.0 °F
Low Setpoint  > 20.0 °F
Enable High   > Yes
Enable Low    > No
Alarm Delay   > 060sec
    
```

```

U01  Space Humidity
      Alarm Set Points

High Setpoint > 60.0 °F
Low Setpoint  > 20.0 °F
Enable High   > Yes
Enable Low    > No
Alarm Delay   > 060sec
    
```

Depending on the setup, Return Humidity or Space Humidity, there are specific High and Low Alarm Set Points both having enable points for high and low alarm. The Enable High and/or Enable Low must be set to Yes in order to the High and/or Low Alarm to trigger when the humidity rises above or falls below the Alarm Set Point. The Humidity must also remain above or below the Alarm Set Point for the Alarm Delay before the Alarm will occur.

## Run Hours

```

U01          Run Hours

Life Hours  > 008579
Supply Blower > 005502
Compressor 1 > 004105
    
```

```

U01          Run Hours

Heater 1 > 002321
    
```

The Run Hours screens above shows Total Run Hours for specific components installed. The Run Hours section tracks total Life Hours of the unit, Supply Blower total run hours and total run hours of compressors and heaters. Should a component be replaced for example, Compressor 1 was just replaced. The total run hours for Compressor 1 is capable of being reset to 000000 hours.

To reset the Run Hours of a component, press the **←** enter button to move the cursor to the field “blank space” next to the desired reset. Press the **↑** (up) or **↓** (down) button and an R will appear. Warning: Make sure the correct component selected is the desired reset required. Should the wrong component be selected and Reset is initiated, the Run Hours of that component will be reset to 0 without a method to set the correct hours of the component back to the true hours. Once this is verified and the R appears, press the **←** enter button to confirm the Reset. All digits within Run Hours for that component are reset to 0 hours.

## 24 Hour Minimum/Maximum Values

```

U01          24 Hour Period
              Minimum/Maximum

              Min          Max
Temp > 69.7 °F      73.7 °F
Humid> 46.9%       54.2%
    
```

The values recorded for Minimum and Maximum take into consideration the setup for Return Temperature and Humidity or Space Temperature and Humidity. Even though it is not displayed, the recorded value is based on the type of sensor listed in the main status menu Return or Space.

## Clock Settings

```

U01          Date/Time change

Format >      MM/DD/YY
Date  >      03/23/17
Hour  >      08:47:45
Day   >      Thursday
    
```

As show in the Date/Time change, the Format of the Date, Present Date, Present Time, and Day of the Week can all be changed. Press the **←** enter button to move the cursor to the field of the desired change. Press the **↑** (up) or **↓** (down) button to change the value and then press the **←** enter button to save the change into memory.



```

U01                Timezone

US EASTERN STANDARD
TIME

Update Timezone: No
  
```

```

U01                Schedule

Enable> Yes
  
```

Press the **↵** enter button to move the cursor to the time zone field. Select the appropriate time zoned using the **↑** (up) or **↓** (down) button to change the value and then press the **↵** enter button move the cursor to the Update Timezone. Selecting Yes and pressing the **↵** enter button again will save the change into memory.

It is possible to set up for specific days to enable only a schedule for those particular days of Occupancy. Press the **↵** enter button to move the cursor to the Enable field for the desired day. Press the **↑** (up) or **↓** (down) button to change the value to Yes to Enable the Schedule and No to Disable the Schedule for that day and then press the **↵** enter button to save the change into memory.

## Schedule

```

U01      Schedule Enables

Mon>Yes  Tue>Yes
Wed>Yes  Thu>Yes
Fri>Yes  Sat>Yes
Sun>Yes
  
```

```

U01      Schedule Monday
                (hh:mm)

Occupied > 7:00
Unoccupied > 20:00
  
```

In order to add an Occupancy Schedule the Schedule must first be enabled. Press the **↵** enter button to move the cursor to the Enable field. Press the **↑** (up) or **↓** (down) button to change the value to Yes to Enable the Schedule and No to Disable the Schedule and then press the **↵** enter button to save the change into memory.

Once the Day of the Week has been enabled for the Occupancy Schedule to occur, the screen for that day will appear within the Schedule sub-menu. Simply setting the Occupied and Unoccupied times will allow the controller to follow the schedule for that day of the week. Should Monday and Wednesday have an Occupied Times but Tuesday is disabled, the unit will go into occupied during the occupied start time and then go into unoccupied and remain unoccupied until the occupied start time on Wednesday.

**Set Back ON and OFF Times**

Should Set Back be enabled under the Set Back Menu, the Set Back Schedule will appear here under the Schedule sub-menu.

```

U01      Set-Back Monday
          (hh:mm)

Setback ON >18:00
Setback OFF>20:00
    
```

The Set Back ON is the Start time for the unit to be in the Set Back Mode. The Set Back OFF is the stop time for Set Back Mode. The unit will either go back into Occupied Mode or into Unoccupied Mode depending on how the Schedule is set up. The Set Back Set Points for Cooling, Heating, Humidification, and Dehumidification all appear under the Set Back Menu.

**Set-Back**

Under the Set Back sub-menu, the following screens appear to allow set up of the Set Back feature to allow each Mode of Operation to work in the Set Back Mode.

```

U01      Enable Set - Back
          Control

Cooling   >Yes
Heating   >Yes
Dehumidify >Yes
Humidify  >Yes
    
```

Enable each of the Modes of Operation that should operate during the Set-Back Mode. The enable points and set points follow the same principle. Cooling will automatically appear. Heating will only appear if heaters are enabled within the

Factory Menu. Dehumidification will appear when either the Return Humidity or Space Humidity Sensor is enabled, and Humidification will only appear when either the Return Humidity or Space Humidity is enabled and a Humidifier is installed.

```

U01      Set-Back
          Cooling

Setpoint > 76.0 °F
Prop Band > 02.0 °F
    
```

```

U01      Set-Back
          Dehumidification

Setpoint > 55.0%
Prop Band> 05.0%
    
```

```

U01      Set-Back
          Heating

Setpoint > 70.0 °F
Prop Band> 02.0 °F
    
```

```

U01                Set-Back
                   Humidification

Setpoint > 45.0%
Prop Band> 05.0%
  
```

```

U01                Unoccupied
                   Cooling

Setpoint > 78.0 °F
Prop Band> 02.0 °F
  
```

Shown above are the Set-Back screens available for change Set Points for the Modes of operation for Set-Back control.

```

U01  Enable Unoccupied
      Control

Blower ON  >Yes
Cooling    >Yes
Heating    >Yes
Dehumidify >Yes
Humidify   >Yes
  
```

```

U01                Unoccupied
                   Heating

Setpoint > 68.0 °F
Prop Band> 02.0 °F
  
```

Enable each of the Modes of Operation that should operate during the Unoccupied Control Mode. The enable points and set points follow the same principle. Cooling will automatically appear. Heating will only appear if heaters are enabled within the Factory Menu. Dehumidification will appear when either the Return Humidity or Space Humidity Sensor is enabled, and Humidification will only appear when either the Return Humidity or Space Humidity is enabled and a Humidifier is installed.

```

U01                Unoccupied
                   Dehumidification

Setpoint > 58.0%
Prop Band> 05.0%
  
```

```

U01          Unoccupied
              Humidification

Setpoint >   40.0%
Prop Band>   05.0%
    
```

```

Technician Menu 01

>>>Fan Settings <<<

↵ / ↵ Scroll Up/Down
↵ Enter Selected Menu
Esc to Previous
    
```

Shown above are the Unoccupied Control screens available for changing Set Points for the Modes of operation for Unoccupied Control.

The Fan Settings sub-menu allows technicians to adjust Time Delays with Fans and Blowers as well as Damper Delays.

## CHANGE PASSWORD

```

U01          Basic Password

Basic        >Disable
Password     >0000
    
```

```

Technician Menu 02

>>>System Units <<<

↵ / ↵ Scroll Up/Down
↵ Enter Selected Menu
Esc to Previous
    
```

The Change Password screen allows for a Basic Password to be installed for protection of set points and other Main Menu items from unauthorized users. The password must first be enabled and then the Password can be changed to a value between 0 and 9999.

The System Units sub-menu allows technicians to adjust the type of data displayed as either Imperial or System International.

## Technician Menu

The Technician Menu is a sub menu of the Main Menu that allows Technicians to access the system for minor adjustments of settings and parameters of the system and view functions of specific components to troubleshoot/diagnose problems with components.

```

Technician Menu 03

>>>Network <<<

↵ / ↵ Scroll Up/Down
↵ Enter Selected Menu
Esc to Previous
    
```

The Network sub-menu allows technicians to set up the network based on the application primarily from an alarms and unit transfer stand point. It also allows them to set the number of days between rotations to the next unit. And allow the system to know in applications with 3 or greater units in a network if any units should remain on continuously without rotating to the off or stand-by position.

```

Technician Menu 04

>>>Manual Control <<<

↵ / ↵ Scroll Up/Down
↵ Enter Selected Menu
Esc to Previous
    
```

The Manual Control sub-menu allows technicians the ability to manually turn components on or off, manually adjust modulating output devices, and manually adjust sensor readings all to be able to test a unit and/or system.

```

Technician Menu 05

>>>Sensor Setup <<<

↵ / ↵ Scroll Up/Down
↵ Enter Selected Menu
Esc to Previous
    
```

Sensor Setup is a sub-menu that allows technicians to calibrate sensor readings, set up custom sensors, add a field purchased (consult factory first) sensor in the event that the customer has a failed sensor and a critical application that the unit needs to be running that same day and they cannot wait for a factory supplied original sensor. It also allows adjustment of Minimum and Maximum output settings for the Modulating Analog Output devices connected to the controller.

```

Technician Menu 06

>>>Digital Inputs <<<

↵ / ↵ Scroll Up/Down
↵ Enter Selected Menu
Esc to Previous
    
```

The Digital Inputs sub-menu is used to set the direction (normally open or normally closed) any interconnected devices are desired to alarm, be active, or inactive.

**IMPORTANT!** Please do not adjust factory provided devices. Primarily only field provided components should be adjusted based on the direction the component is active (open or closed).

```

Technician Menu 07

>>>Economizer <<<

↵ / ↵ Scroll Up/Down
↵ Enter Selected Menu
Esc to Previous
    
```

The Economizer sub-menu allows customer to adjust the settings with Airside and Waterside Economizer.

```

Technician Menu 08

>>>Blower VFDs <<<

↵ / ↵ Scroll Up/Down
↵ Enter Selected Menu
Esc to Previous
  
```

The settings for Blower VFDs sub-menu are only available with factory provided VFD's that are interconnected to the controller via Modbus control. It allows technicians to view status and make minimal adjustments to the VFDs.

```

Technician Menu 09

>>>Change Passwords <<<

↵ / ↵ Scroll Up/Down
↵ Enter Selected Menu
Esc to Previous
  
```

The Change Passwords sub-menu under the Technician Menu allows the technician/customer the ability to Enable Basic and or Technician Passwords.

```

Technician Menu 10

>>>Information <<<

↵ / ↵ Scroll Up/Down
↵ Enter Selected Menu
Esc to Previous
  
```

The Information sub-menu provides information about the software version, operating system version and other detailed information about the installed controller.

## FAN DELAYS

```

U01           Damper Delays

Unit Start> 015sec
Damper Delay> 060sec
  
```

```

U01           Blower Delays

Blower Start >015sec
Blower Min ON >030sec
Blower Min OFF >030sec
Airflow Check >060sec
  
```

The Damper Delays and Blower Delays allow adjustment of system delays. The Unit Start delay is the length of time between the Unit ON/OFF switch and when the Damper starts. The Damper Delay is the length of time that the damper output must be on before the Supply Air Blower can start. The Blower Min ON delay is the amount of time that the blower must be on before it can turn off. The Airflow Check delay is the amount of time that the blower must be on before any mode(s) of operation (Cooling, Heating, Humidification, and Dehumidification) can start. Once this delay has elapsed, the system is verified for air flow and if the air flow is proven good, the modes of operation and start. If air flow is not proven, the Loss of Airflow Alarm will be posted, no modes of operation will start and the blower output will de-energize. The Blower Min OFF is the amount of time that the blower must remain off once it is de-energized.

## SYSTEM UNITS

```

U01          Units Setup

Unit Type>Imperial
  
```

The Units Setup is the screen to apply the type of units preferred Imperial or SI.

## NETWORK

The Network Setup screens are used to setup interconnected units in a networking application. Typically this first screen will be set up by the factory and normally does not require adjustment(s). Total Units is the Total number of units connected within the networking application. Standby Units is the total number of units to remain in stand-by mode within the total number of units within the network. Enable Rotate allows the units within the Total Units and Standby Unit to rotate on or off within the network. Rotate Now allows technicians to force a Rotation to make sure a unit that is presently operating goes into stand-by mode and brings the next unit required out of stand-by to the on position. Shift Delay is the amount of time between the time a unit presently operating shuts down and goes into stand-by mode and the start of the next unit from the stand-by mode to the on position.

```

U01          Network Setup

          Continuous Units

U01>Yes     U05>No
U02>Yes     U06>No
U03>Yes     U07>No
U04>No      U08>No
  
```

```

U01          Network Setup

Continuous Units

U09>No      U13>No
U10>No      U14>No
U11>No      U15>No
U12>No      U16>No
    
```

The System Rotations allows technicians or customers to adjust the amount of days between rotating to the next unit in line. The Rotate Time is the time of day in 24-hour format that the unit rotation is supposed to occur.

```

U01          Network Setup

Rotate on Alarm>Yes
Unit OFF>Yes
    
```

The Rotate on Alarm will allow the units to shut down when an alarm occurs within a unit that is operating. If a unit shuts down due to an alarm, another unit within the network (if available) will be brought on. Unit OFF when set to Yes will turn off the unit that went into alarm.

```

U01          Network Setup

System Rotations

Between Rotate>007 days
Rotate Time    >01:00
    
```

If the number of units networked is greater than three (3), the screens above for Continuous Units will appear. If any units are supposed to remain on continuously, setting each of the units required to remain on to Yes will allow them to remain on continuously within the existing networked application. The total amount of units that appear here will match the Total Units in the network.

```

U01          Network Setup

Alarm Transfers:

Airflow                >Yes
Drain Pan               >Yes
Comp 1 HP or LP        >Yes
    
```

Setting any of the Alarm Transfers listed above will automatically transfer the unit with alarms to the standby mode and bring the next unit in line within the network out of stand-by to the on position.



## SENSOR SETUP

```

U01          Return Temp

Actual > 073.00 °F
Offset > 000.00 °F
Custom > Yes
Type > 0-10vdc
Minimum > -050.00 °F
Maximum > 150.00 °F
    
```

```

U01          Supply Temp

Actual > 073.00 °F
Offset > 000.00 °F
Custom > No
    
```

The screens above are two variations of setups. The Offset is that calibration adjustment for the sensor.

One of the biggest benefits of the Marvel controller is the ability to add a field replacement sensor when a sensor has failed and it is imperative to get the unit back up and running immediately. Typically Factory Supplied Sensors are not custom sensors. If a field replacement was purchased locally (Please consult the factory about types before doing so), Setting the Custom to Yes will allow the adjustments for Type of Sensor and Range of sensor (Minimum/Maximum) to appear. These settings must be configured for the sensor that was purchased.

```

U01          Sensor Filtering

AIN 01 > 7
AIN 02 > 5
AIN 03 > 9
AIN 04 > 5
AIN 05 > 5
    
```

The sensor filtering value takes a number of readings over a period of time and outputs the average value over a period of time for the number of readings. The higher the number, the more readings will be allowed over a period of time.

```

U01          Analog Output 1

ECM Press

Minimum >          3.0vdc
Maximum >          10.0vdc
    
```

```

U01          Analog Output 2

Air Econo

Minimum >          2.0vdc
Maximum >          10.0vdc
    
```

The Analog Output screens above allow for component adjustment of Minimum and Maximum allowable vdc

output for that component enabled under that particular Analog Output. In the examples above, Analog Output 1 is enabling for ECM Press or ECM Blower for variable air volume duct pressure control. The Minimum Output voltage to the Electronically Commutated Motor is 3.0 volts dc. This means the blower will always be 30% of the maximum when the blower is on. Airside Economizer is enabled on Analog Output 2. The minimum output is adjusted to 2.0 volts dc. This is simply because the type of damper actuators installed is a 2.0 to 10.0 vdc type.

### MANUAL CONTROL

U01	Manual Dig-Out
01	>Compressor 1 >Auto
02	>Compressor 2 >Auto
03	>Compressor 3 >Auto
04	>Compressor 4 >Auto
05	>Unassigned
06	>Unassigned

U01	Manual Dig-Out
07	>Supply Blower >Auto
08	>O/A Damper >Auto
09	>Unassigned
10	>Unassigned
11	>Unassigned
12	>Water Pump >Auto

In the screens above for Manual Control, Manual Control allows any of the above devices to be turned on manually. Under Manual Dig-Out, AUTO means that the device will turn on or off based on the demand for the device to be on or off. OFF means that the component will be off until either set to ON or AUTO mode. ON means that the component will be on until either set to the OFF or AUTO position.

U01	Analog Outputs		
ECM Press	OFF	0.0v	
Air Econo	OFF	0.0v	
DPC Valve 1	OFF	0.0v	

Under the Analog Outputs, OFF means the analog output will be modulated up or down automatically based on the demand for the component. Setting the OFF to ON means that the modulation can be increased or decreased between 0.0 and 10.0 vdc based on requirement to test the component.

### DIGITAL INPUTS

U01	Dig-Inputs Setup	
	State	Alarm
Duct Hi-Lim	cl	op
Fire/Smoke	cl	op
Ext ON/OFF	cl	op
Filter	cl	op
Water Flow	cl	op

The Digital Inputs Setup screen allows devices such as Ext ON/OFF (Remote ON/OFF), field provided Fire/Smoke Detectors, etc. to be set for the proper switching state. Some devices can be configure to work on contact closure, other require open contacts. The Alarm column may be changed to Alarm on cl or (contact closure) depending on the field device installed. **IMPORTANT:** Never change the Alarm position of the compressor high and low pressure switches unless it is desired to test the digital input for failure. When doing so, please remember to set the Alarm back to the op position.

## ECONOMIZER

```
U01      Economizer Setup

Type:
  >Air& Mod Water Valve
  Assist>Enable

Damper Minimum> 000%
Damper Maximum> 100%
```

```
U01      Economizer Assist

Delay > 15min
Start > 100%
End   > 50%
Comps > 3
(Comps-Total comps
allowed to assist)
```

The above screens for Economizer Setup and Economizer Assist allow for setup of the Economizer package. The parameter for Type of Economizer can be set. If mechanical cooling assist is required, Assist can be Enabled so that Mechanical Cooling Compressors can assist economizer mode. **CAUTION:** Please consult the factory for Assist requirements as not all units may be capable of having compressor run while economizer mode is on).

If the Economizer Type is Airside Economizer, the Minimum output and Maximum outputs can be set for Economizer Dampers to meet fresh air and maximum air flow requirements. Economizer Assist requires that the demand for economizer must be equal to the compressor Start Demand for the Delay Time before the compressors can assist. The total number of compressors applied will sequence on with a delay between stages up to the maximum number of compressors allowed to assist as set into the Comps-Total compressor allowed to assist setting. The End setting is the Economizer Demand value set point where compressors will stop assisting and only Economizer mode will operate.

## CHANGE PASSWORDS

The Enable Password screens allow for enabling of the Basic and/or Technician Passwords. The passwords can be a value between 0 and 9999. Please record the passwords if installed.

```
U01      Enable Passwords

Basic User>Disable
Technician>Enable
```

```
U01      Enable Passwords

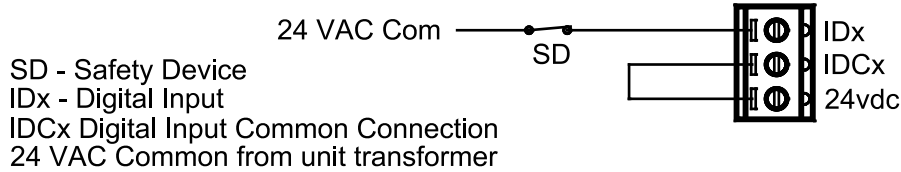
Basic User>0000
Technician>9995
```

## SYSTEM INFORMATION

```
U01      Information

          United CoolAir
          Marvel Premium Controller

Version   >1.1.00 1 0p
System>4.1.005
```



**FIGURE 16 – DIGITAL INPUT TERMINATION REFERENCES**

```

U01      Information

          United CoolAir
          Marvel Premium Controller

Job Number>026479
Op System >4.1.005
  
```

The Information Screens above are displayed based on either a Version Number or by a Job Number. If the software is a standard version, the verbiage “Version” will be displayed followed by the version number. Should the system have custom software, the verbiage “Job Number” followed by the United CoolAir Job Number will be displayed. On the last line, the Operating System version is displayed.

```

U01      Information
System Info
Board Type>          c.pC0
Board Size>          Large
Board Temp>          104 °F
PermMem Writes>0005400
Main Status:
150ms 5.6cycles/sec
  
```

The last screen within the Information sub-menu provides details about the installed controller.

**INPUT WIRING**

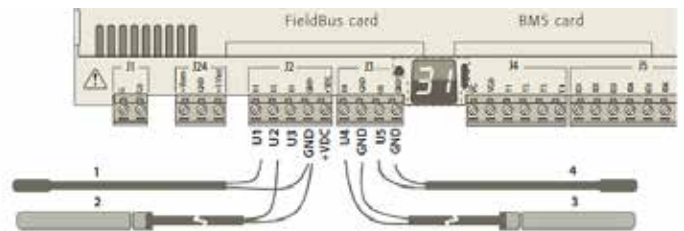
**Digital Inputs**

The Digital Inputs on the Marvel can accept and perform any of the control functions listed for Digital Inputs on page 4. The digital inputs are designed to work with 24 VAC or 24 VDC. When using the digital inputs with a dc voltage source, a 24 V AC/DC common must be wired to the actual digital input, and must also be the same as the connection to the G0 terminal which is normally referenced to ground. The +24 VDC would then be wired directly to the IDCx or common for the digital input. Refer to Figure 16 – Digital Input Termination References for further details.

**Analog Inputs**

The Universal Inputs on the Marvel controller are provided for reading any of the listed Universal/Analog Input sensors listed on page 4.

The NTC temperature sensors are connected as shown in Figure 17 – Temperature Sensor Termination References. There is no polarity to the NTC temperature sensors.



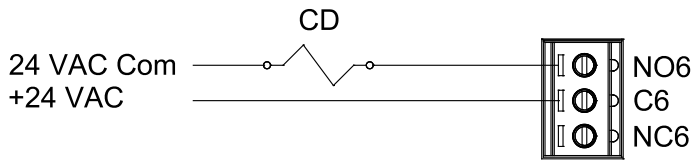
**FIGURE 17 – TEMPERATURE SENSOR TERMINATION REFERENCES**

For all other sensor terminations, please refer to the electrical diagrams provided with the units for electrical connections.

**Digital Outputs**

Relays on a Marvel controller are capable of handling up to

10 Amps Resistive at 1 Amp Inductive loading at 250 VAC to control any of the Digital Output functions listed on page 5. To power a control device (contactor, starter, solenoid coil, etc.) connect the neutral side of the 24 VAC power supply to the control device. Connect the hot side of the 24 VAC power supply through the common C(x) of the digital output relay as shown in Figure 18 – Digital Output Termination References.

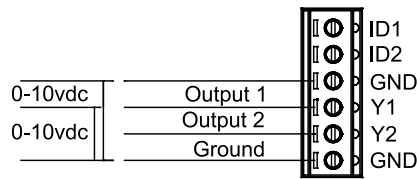


CD - Controlled Device (Contactor, Etc.)  
 C6 Relay Common Input  
 NO6 - Relay Normally Open  
 NC6 - Relay Normally Closed Contact

**FIGURE 18 – DIGITAL OUTPUT TERMINATION REFERENCES**

**Analog Outputs**

The Analog Outputs on a Marvel controller are capable of providing modulating output voltage of 0 – 10 VDC to control any of the following Analog Outputs listed on page 4. The analogs outputs must be powered externally using 24 VAC. The neutral side of the 24 VAC power supply is connected to terminal VG0. The 24VAC hot side is connected to terminal VG1. Analog Output 1 through Analog Output 6 (Y1 through Y6 respectively) connects to the modulating output for the device being controlled. Refer to Figure 19 – Analog Output Termination References for connection details.



Y1 Output for providing 0-10vdc Modulating Signal to Device  
 Y2 Output for providing 0-10vdc Modulating Signal to Device  
 GND - Reference point to Ground for 0-10vdc modulated device.

**FIGURE 19 – ANALOG OUTPUT TERMINATION REFERENCES**

**OPTIONAL BOARDS**

**Building Management Systems (BMS Systems)**

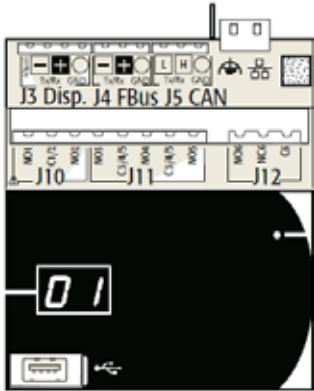
Several methods of supervisory systems may be used to communicate with the Marvel Main Board which allow for monitoring of the systems readings, changing/offsetting of set points and remotely view alarm status. The following is a list of BMS Systems the Marvel Control can interface with:

BACnet™	ModBus®	pCOWeb
---------	---------	--------

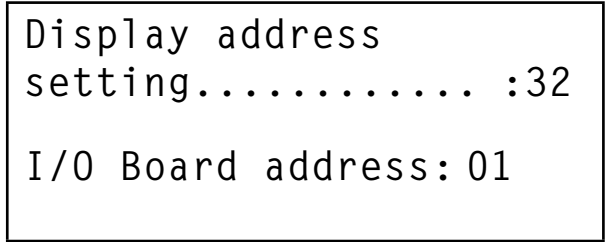
**SYSTEM NETWORKING**

Two or multiple units may be networked as shown in Figure 1 previously. The networks are preconfigured during the operational testing at the factory using Ethernet Cables.

1. Connect field supplied Ethernet Cables between the controllers as shown in Figure 20 – System Networking below.
  - a. Network wiring between each unit must be installed between each unit as follows:
    - i. Unit 1 connects to Unit 2
    - ii. Unit 2 to Unit 3
    - iii. Unit 3 to Unit 4 and so on.
  - b. Network wiring must be 4 Conductor Minimum 20 AWG shielded cable.
2. Should there be a need to re-order the number of unit identification, Figure 21 – Adjusting pLAN Addresses below displays the location and momentary push button access for renumber the plan networking addresses.
  - a. Simply insert a very small screw drive in through the momentary pushbutton opening.
  - b. Depress the button one time and the LEDs shown at 31 will illuminate to a higher intensity.
  - c. Once they are brighter, keep pressing the button until the desired plan address is achieved.
  - d. Stop depressing the button to save the plan address into memory.

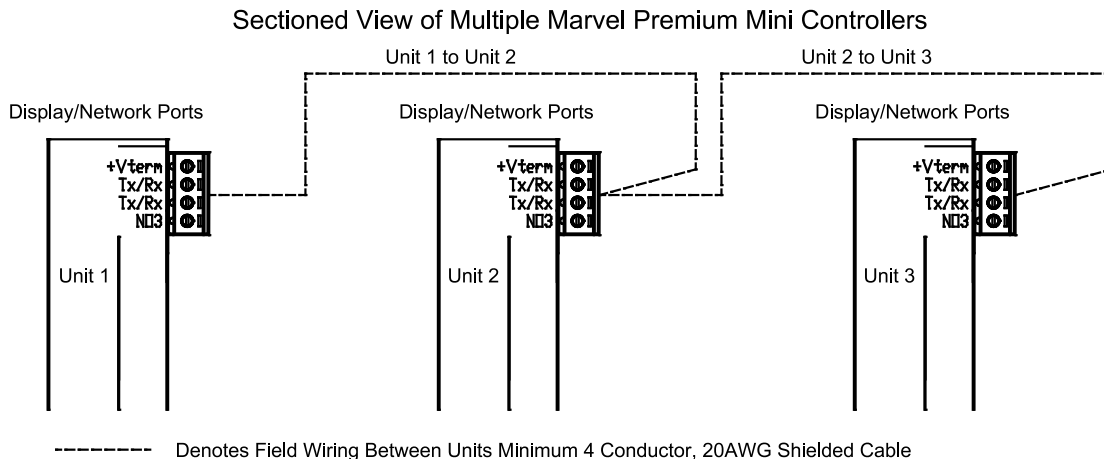


**FIGURE 21 – ADJUSTING PLAN ADDRESSES**



3. If the units were ordered from the factory as a networking system, the following procedure will have already been completed and tested. Each unit must be shared with the Marvel Terminal/Wall Display. In order to do this, disconnect power to all but one unit. Each unit will be updated one at a time.
4. Press the ↑ (up), ↓ (down) ↵ (enter) and buttons simultaneously for 5 seconds until the following screen appears.

5. Make sure the display address it set to a 32. On the present unit being updated, the I/O Board address should automatically appear. If it does not appear, a -- will appear. Simply position the blinking cursor over the -- by pressing the ↵ (enter) it is positioned at this location. Press the ↑ (up) or ↓ (down) button until the pLAN address shown in Figure 20 appears at this location. Press the ↵ (enter) button until the next screen appears and then once this screen appears, press the ↵ (enter) button again till the Priv/Shared Screen as shown appears.



**FIGURE 20 – SYSTEM NETWORKING**

```

Terminal config
Press ENTER
To Continue
    
```

positioned under the NO and use the **↑** (up) button to change the value to Yes. Once this is finished, the main status screen will reappear.

```

P:01  Adr   Priv/Shared
Trm1  32    Sh
Trm2  None  --
Trm3  None  -- ok?NO
    
```

6. Trm1 must be a value of 32 to match the value previously set. If it is not a 32, use the **↑** (up) or **↓** (down) buttons to change the value to a 32 then press the **↵** (enter) button to save it into memory. Next, use the **↑** (up) or **↓** (down) buttons to change the value under Priv to make sure that if Pr is displayed, the value must be Sh for Shared and then press the **↵** (enter) button to save it into memory. Continue to press the **↵** (enter) button until the blinking cursor is

7. At this point, power this unit down and repeat the previous steps to share each unit with the Marvel Terminal. It is easiest to do one unit at a time making sure that power is applied only to the unit being updated. Once all units have been updated, power can be applied to all units.

Authorized Distributor:

[Empty dotted box for Authorized Distributor information]

**LIMITED WARRANTY**

United CoolAir Units are backed by a 1 year limited warranty on parts and a 5 year limited warranty on the compressor (labor not included). Maintenance items such as filters and belts are excluded under this limited warranty.

**FACTORY TESTED**

All units are functionally run tested before shipment to ensure a trouble-free start-up and unit commissioning. Industry proven components are used throughout to enhance system reliability and peace of mind.



491 East Princess Street, York, PA 17403 Phone: 717-843-4311 Fax: 717-854-4462  
web: [www.unitedcoolair.com](http://www.unitedcoolair.com)



Copyright © by United CoolAir, LLC 2022. All rights reserved.  
Manufacturer reserves the right to make changes without notice.



UCA024 (0422)